

本次股票发行后拟在科创板市场上市，该市场具有较高的投资风险。科创板公司具有研发投入大、经营风险高、业绩不稳定、退市风险高等特点，投资者面临较大的市场风险。投资者应充分了解科创板的投资风险，并仔细阅读公司所披露的风险因素，审慎作出投资决定。



拓荆科技股份有限公司

(辽宁省沈阳市浑南区东大街900号)

首次公开发行股票并在科创板上市招股意向书

保荐机构（主承销商）

CMS 招商证券

(深圳市福田区福田街道福华一路 111 号)

联席主承销商

国开证券

(北京市西城区阜成门外大街 29 号 1-9 层)

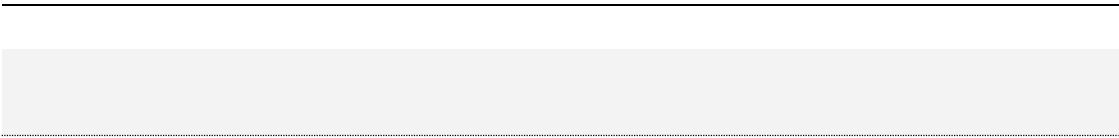



	A
	3,161.9800 25.00%
	1.00
	2022 4 8
	12,647.8797
	2022 1 4
	2022 3 18
	10% 316.1980
	22,256.7750
	12
	158.0990 T-2 5%
	24
	2022 3 29

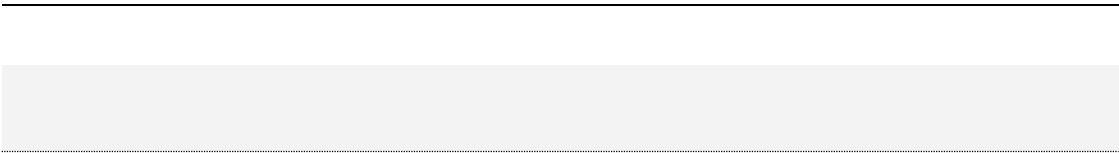

13.02% 19 15 22 27 13.10% 10.95%
12.50%

5,704.87 -10,322.29 -1,936.64 -1,169.99
-14,993.05 -6,246.63 -5,711.62 -2,305.21

10,797.31 7,431.87 12,278.18 12,955.63
152.84% 29.58% 28.19% 34.65%



6-24

3-24

PECVD

ALD

SACVD

SACVD

PECVD ALD
PECVD

PECVD

1-1-4

77.98% 100.00% 97.55%

88.69% ALD SACVD

ALD

14nm

17nm

DRAM

SACVD

40nm

ALD SACVD

ALD SACVD

ALD

SACVD

Demo

Demo

Demo

Demo

Demo

74

Demo

25

33.78%

Demo



2019	CVD	AMAT	
Lam	TEL	30% 21% 19%	ALD
	TEL	ASMI	
31% 29%			

ALD

ALD

100.00% 84.02% 83.78% 92.44%



30%

"

"

"

"

2021 3 31

2021

"

"

"

"

"

"

"

"

"

"

2021

1

	2021 12 31	2020 12 31		
	251,772.82	181,406.91	70,365.91	38.79%
	119,333.76	112,249.87	7,083.89	6.31%
	119,260.77	112,220.97	7,039.80	6.27%

2021 12 31

251,772.82

2020 12

31 70,365.91 38.79%

1

44,107.78

3,071.29

2 2021

12,453.82

3

7,761.86

2021 12 31

119,333.76

119,260.77

2020 12 31

6.31% 6.27%

2

	2021 10-12	2020 10-12		2021	2020	
--	------------	------------	--	------	------	--

	2021 10-12	2020 10-12		2021	2020	
	38,406.52	27,232.88	41.03%	75,796.09	43,562.77	73.99%
	1.58	4,454.92	-99.96%	5,628.70	-1,375.68	-
	999.58	4,459.13	-77.58%	6,737.85	-1,169.99	-
	987.86	4,459.13	-77.85%	6,692.73	-1,169.99	-
	1,052.27	4,480.22	-76.51%	6,848.65	-1,148.90	-
	-5,894.98	1,176.03	-	-8,200.19	-5,711.62	-
	21,345.33	41,969.59	-49.14%	13,748.06	30,891.27	-55.50%

2021 2020 11,173.64
41.03% 2021 2020
32,233.32 73.99%

2021 2020 3,427.95
76.51% 2021 2020
4,464.65 10,851.58

2021 2020 7,997.55

2021
20,624.26 2021 2020
17,143.21

3

2021 15,048.84

2021

15,553.46

2022

	2022 1-3	2021 1-3		
	10,000.00 12,000.00	5,774.10	4,225.90 6,225.90	73.19% 107.82%
	-2,000.00 -700.00	-1,032.66	-967.34 332.66	-
	-3,000.00 -1,600.00	-2,400.90	-599.10 800.90	-

2022

7

2019

12

18,354.00

7

966

"

" "

5%

" "

5%

" " 2

5%

"

7

6.5710%

0.8212%

1

5,235.2715

39.6611%

1

2021 8 6

2021

0107 2219

" "

2020 4 26

2020 6-7

2

2020 5

3

2020 10 23

"

"

2021 1 12

28

2

1

2020 11 17

2021 8 6

2021 8 12

2022

2 25

2

2021 1 31

275.5406

2021 4 16

2021 7 7

3

6.5710%

623.3158

2021 3 1

2021 04 49

275.5406

2.9047%



55%

"

" "

"

"

"

"

"

"

"

20% 10%

10%

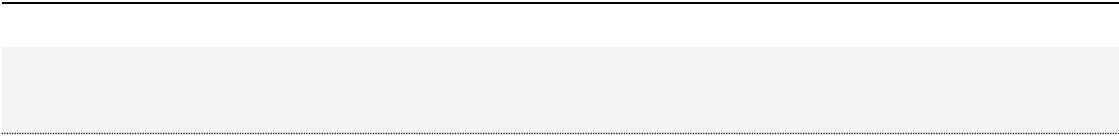

..... 1

..... 2

..... 3

..... 3

..... 7

..... 7

..... 7

..... 10

..... 15

..... 20

..... 20

..... 22

..... 26

..... 26

..... 26

..... 28

..... 29

..... 32

..... 32

..... 33

..... 34

..... 34

..... 36

..... 36

..... 37

..... 39

..... 40

.....	40
.....	45
.....	45
.....	45
.....	46
.....	49
.....	49
.....	50
.....	51
.....	51
.....	51
.....	57
.....	59
.....	60
.....	60
.....	61
.....	61
5%	63
.....	74
.....	79
.....	89
.....	90
.....	91
.....	93
.....	94
.....	96

.....	99
.....	102
.....	102
.....	110
.....	138
.....	148
.....	152
	164
.....	168
.....	169
.....	169
.....	171
.....	171
.....	172
.....	172
.....	172
.....	173
.....	173
.....	173
.....	175
.....	175
.....	192
.....	193
.....	194
.....	194
.....	204
.....	206
.....	206

.....	207
.....	207
.....	216
.....	217
.....	218
.....	219
.....	222
.....	257
.....	282
.....	290
.....	291
.....	291
.....	292
.....	292
.....	294
.....	301
.....	301
.....	304
.....	304
.....	304
.....	308
.....	308
.....	309
.....	312
.....	312
.....	316
.....	316

	317
	318
	318
	321
	322
	324
	325
	326
	327
	328
	329
	330
	331
1	332
2	332
3	334
4	337
5	345

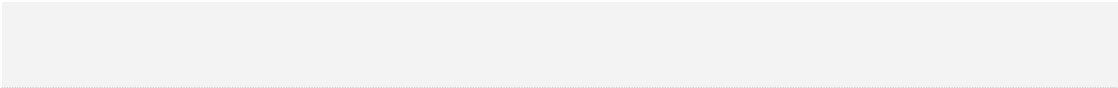

		8 11
		AMAT Applied Materials, Inc. NASDAQ 4336
		LRCX Lam Research Corporation NASDAQ " " " "
		Novellus Systems Inc. NASDAQ NVLS 2012 6
		ASM International ASM
		Intel Corporation CPU
		Samsung Electronics Corporation CPU
KE		KOKUSAI ELECTRIC CORPORATION " KE"
		ICRD
		DRAM IDM

		IDM
		IDM
ICRD		Shanghai IC R&D Center
		002371.SZ
		688037.SH
		688082.SH
		A20569.SH
SEMI		Semiconductor Equipment and Materials International
Gartner		Gartner Group 1979 IT IT
Strategy Analytics SA		
		2018 2019 2020 2021 1-9
		2021 9 30

		2018 12 31	2019 12 31	2020 12 31	2021 9 30
		2018 12 31	2019 12 31	2020 12 31	2021 9 30
		2018	2019	2020	2021 1-9

		Silicon Wafer				4	6
		8	12				
IDM		Integrated Device Manufacture					
						90nm 65nm	
		40nm	28nm	14nm	7nm	5nm 3nm	
k						k	
						28nm/14nm	
Demo						Demo	
Demo						Demo	
						LED	
CMOS CMOS		Complementary Metal Oxide Semiconductor					
		N-MOS	P-MOS				

FinFET FinFET		Fin Field-Effect Transistor
Fin		3D FinFET
		3D WLP SiP FC TSV 2.5D
2.5D		
3D TSV		TSV Through-siliconvia TSV TSV TSV 3D TSV
Etch		
CVD		Chemical Vapor Deposition
PECVD		Plasma Enhanced Chemical Vapor Deposition
ALD		Atomic Layer Deposition
PE-ALD		Plasma Enhanced Atomic Layer Deposition
Thermal-ALD		Thermal Atomic Layer Deposition
SACVD		Sub-atmospheric Pressure Chemical Vapor Deposition
UV Cure		, UV
LPCVD		Low Pressure Chemical Vapor Deposition
PVD		Physical Vapor Deposition

		PECVD
EFEM		Equipment front-end module
		SiO ₂ SiN SiON
SiO ₂		
TEOS		Tetraethyl orthosilicate SiO ₂
SAF		
BPSG		Boro-phospho-silicate Glass
SiN		
SiON、DARC		Silicon Oxynitride
PSG		Phospho-silicate Glass
		-Si Lok Lok ADC ADC ACHM
ACHM		
Lok		
Lok		Lok Lok
ADC		Nitrogen Doped Carbide
ADC		Oxygen-doped Silicon Carbide
-Si		Amorphous Silicon
ONON NO stack No stack		- - - 3D NAND SiO ₂ SiN
Thick TEOS		TEOS
SADP		Self-Aligned Double Patterning Fin FinFET
STI		Shallow Trench Isolation 0.25um

BSI	BSI	Back Side Illumination	CMOS
	FEOL	FEOL	
	BEOL	BEOL	
	ILD	Inter Layer Dielectric	
	IMD	Inter Metal Dielectric	
	PMD	Pre-Metal Dielectric	
	NFDARC, SiOC	Nitrogen Free Dielectric anti-reflective coating	



			2010 4 28
	9,485.8997		
	900		900
	C35		

	A		
	1.00		
	3,161.9800		
	3,161.9800		25%
	12,647.8797		

	12.45 9 30	2021	-0.60 2020
	A		
	ALD		

1
 100,029.65 100,029.65
 4.5% 100,029.65
 6%

2 1,188.68
 3 613.21
 4 518.87
 5 13.86
 1 2

1		2022 3 29
2		2022 4 1
3		2022 4 7
4		2022 4 8
5		2022 4 12
6		

	2021.9.30/ 2021 1-9	2020.12.31/ 2020	2019.12.31/ 2019	2018.12.31/ 2018
	234,529.89	181,406.91	107,411.69	92,644.56
	118,090.11	112,220.97	81,426.96	69,415.35
	48.25%	36.41%	24.19%	25.07%
	37,389.57	43,562.77	25,125.15	7,064.40
	5,704.87	-1,169.99	-1,936.64	-10,322.29
	5,796.38	-1,148.90	-1,936.64	-10,322.29
	-2,305.21	-5,711.62	-6,246.63	-14,993.05
	0.61	/	/	/
	0.61	/	/	/
	5.03%	-1.11%	-2.83%	-13.86%
	-7,597.27	30,891.27	-2,175.61	-12,801.52

	2021.9.30/ 2021 1-9	2020.12.31/ 2020	2019.12.31/ 2019	2018.12.31/ 2018
	34.65%	28.19%	29.58%	152.84%

ALD

PECVD

SACVD

14nm

10nm

PECVD SACVD

/

2016 2017 2019 "

"

2022 3 8 174 153

21 98 77 21

2017 "

2016 " 2019

" 2021

" "

1

PECVD ALD SACVD

2

3



5

Demo

2019

"

2016

2017

"

PECVD SACVD

" 90-65nm " " 1x nm 3D NAND
PECVD " /

64/128 3D NAND FLASH 28/14nm 19/17nm DRAM
2.5D 3D

25,125.15 43,562.77 37,389.57 7,064.40

3

					2012 C35
					GB/T4754-2017
		C3562			
					2018
			" 1		
		-1.2	-1.2.1		-
			"		

1

				30,507.37	6,000.00 75,752.32
				40.27%	5%
				2021 9 30	
	10%			189	429
				10%	44.06%
				2022 3 8	
				5	98
				2018 2020	
				7,064.40	25,125.15 43,562.77
					148.32%
				20%	
				4.36	3

2

"		

"		/
		PECVD PECVD SACVD
50		2022 3 8 98

	7,986.46	7,986.46	7.98%
	39,948.34	39,948.34	39.94%
ALD	27,094.85	27,094.85	27.09%
	25,000.00	25,000.00	24.99%
	100,029.65	100,029.65	100.00%





	A
	1.00
	25.00% 3,161.9800
	2022 1 4 2022 3 18 316.1980 10% 22,256.7750 12
	T-2 5% 158.0990 24
	12.45 2021 9 30
	A

	<p>1</p> <p>100,029.65 100,029.65</p> <p>4.5% 100,029.65</p> <p>6%</p> <p>2 1,188.68</p> <p>3 613.21</p> <p>4 518.87</p> <p>5 13.86</p> <p>1</p> <p>2</p> <p>0.025%</p>

	900
	024-24188000
	024-24188000-8080

	111
	0755-82943666

	0755-82943121
--	---------------

	29 1-9
	010-88300772
	010-88300793

	20 3 22-31
	010-59572288
	010-65681022

--	--

1366

	010-65881818
	010-65882651

	19 37 305-306
	010-52596085
	010-88019300

	388
	021-68808888
	021-68804868

	188
	021-58708888
	021-58899400

	3 AB
	819589015710001

2021 11 29
688012.SH 160 A 0.000026%

0.0000029%

22.29%

45.00%

26.48%

1		2022 3 29
2		2022 4 1
3		2022 4 7
4		2022 4 8
5		2022 4 12
6		

"

"

474.2970

15.00%

2% 5%

10 5% 4,000

10 20 4%

6,000 20 50 3%

1

50 2% 10

5% 158.0990

2022 1 4

2022 3 18

10% 316.1980

22,256.7750

--	--

	2022 3 8
	SVF025
	22,256.7750
	22,256.7750

1			2,954.7000	13.28%		
2			720.0000	3.23%		
3			1,688.4000	7.59%		
4			2,427.0750	10.90%		
5			1,336.6500	6.01%		
6			2,356.7250	10.59%		
7			1,055.2500	4.74%		
8			1,231.1250	5.53%		
9			773.8500	3.48%		
10			703.5000	3.16%		
11			703.5000	3.16%		
12			703.5000	3.16%		
13			633.1500	2.84%		
14			422.1000	1.90%		
15			352.0000	1.58%		
16			351.7500	1.58%		
17			281.4000	1.26%		

18			281.4000	1.26%		
19			281.4000	1.26%		
20			281.4000	1.26%		
21			211.0500	0.95%		
22			211.0500	0.95%		
23			211.0500	0.95%		
24			211.0500	0.95%		
25			201.0000	0.90%		
26			160.0000	0.72%		
27			140.7000	0.63%		
28			140.7000	0.63%		
29			140.7000	0.63%		
30			140.7000	0.63%		
31			140.7000	0.63%		
32			140.7000	0.63%		
33			137.5000	0.62%		
34			130.0000	0.58%		
35			100.5000	0.45%		
36			100.5000	0.45%		
37	GiYoul Kim		100.0000	0.45%		
38			100.0000	0.45%		
			22,256.7750	100.00%		



1

100%

2

3

4

24

12

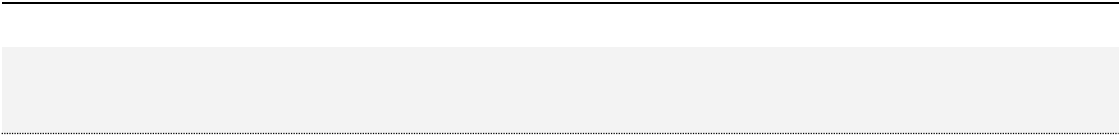

" " " " "

"

" " " " "

"

PECVD ALD SACVD

" " " " "

PECVD ALD SACVD

"

Demo

" " " " "

Demo

"



" " " " "

" " " " "

" " " "

" " " "

"

33.00% 31.99% 34.12% 45.55%

7,406.55 12,356.92 2018-2020 6,540.84 13,476.81
92.59% 53.64% 17.00%

52,381.17 99,031.84 33,052.11 35,782.99
48.61% 47.61% 41.78% 32.55%

17,016.48 23,503.18 36,746.35 59,321.12
51.48% 65.68% 70.15% 59.90%

				-12,801.52
-2,175.61	30,891.27	-7,597.27		
				2,475.84
21,344.45	26,997.70			37.34%
86.16%	62.97%			
			4,221.41	3,686.86
25,114.58	5,166.20			19.79% 13.50%
27.61%	6.58%			4,691.53
	4,326.27	5,096.14	8,074.57	
66.41%	17.22%	11.70%	21.60%	



2020

2018

" " " " "

2020

	Piotech Inc.
	9,485.8997
	2010 04 28
	2021 1 12
	900
	110168
	024-24188000
	024-24188000-8080
	http://www.sypiotech.cn
	ir@sypiotech.cn
	024-24188000-8089

2010 4 28 1,000

600 400

60% 40%

2021 1 8

[2020]10046 2020 5 31

1,161,768,550.19 94,858,997 1

1,066,909,553.19

2021 1 12

2021 6 15

94,858,997

2021 5 21

[2021]7249

2021 5 21

2018

	114,281.27	25,851.77	88,429.50	25,125.15	-661.87
	-7,615.41	-	-7,615.41	-	-896.07
	416.40	-	416.40	-	166.23
	329.42	329.42	-	-	-

			%
11		150.0000	1.5813
12		138.0996	1.4558
13		138.0546	1.4554
14		138.0416	1.4552
15		138.0205	1.4550
16		138.0186	1.4550
17		137.9725	1.4545
18		137.7926	1.4526
19		123.4290	1.3012
20		99.0099	1.0438
21		78.7500	0.8302
22		77.8947	0.8212
23		62.7900	0.6619
24		50.0000	0.5271
25	YIJUN LIU	28.0000	0.2952
26	FUHUA LING	25.5000	0.2688
27		23.7450	0.2503
28	BIAO WU	17.5000	0.1845
29	REN ZHOU	17.5000	0.1845
30		16.8850	0.1780
31	SIAN CHE CYNTHIA CHANG	16.0000	0.1687
32		15.0000	0.1581
		9,485.8997	100.0000

"

"

2021

1-1-54

1

2020 5 31

-28,126.78

2

2020 6 1 2020 12 31

41,991.94

2,650.28

3

	2021 1-9	2020 6-12	2020 1-5	2019	2018
	-25,476.50	-28,126.78	-24,327.60	-22,390.96	-12,068.67

	2021 1-9	2020 6-12	2020 1-5	2019	2018
	5,796.38	2,650.28	-3,799.18	-1,936.64	-10,322.29
	-28,126.78	-	-	-	-
	8,446.65	-25,476.50	-28,126.78	-24,327.60	-22,390.96

4

"

"

"

"

"

"

"

5

	2020 5 31		1,088,954,920.92
	94,858,997.00	1,274,060,433.49	1,303,267.08
	-281,267,776.65		94,858,997
1	-	994,095,923.92	

[2021]120

	94,858,997.00
	1,274,060,433.49
	1,303,267.08
	-281,267,776.65
	94,858,997.00
-	994,095,923.92

2018 1 1

			%
1		2,512.1755	35.2959
2		1,729.7297	24.3026

2019 5

2019 5

3.9646%

19 /

2019 5 6

2019 5

2019 5

4.215%

2019 5

4.215%

5,700

2019

4 23

2019 5 17

2019 7

2019 7

2.1075%

19.18 /

2,887.0245

2019 7 12

2019 12

701.2105

623.3158

77.8947

966

2019 12 27

2020 5 19

2020 03003

2021 1 14

	[2021]116		2020	5	18	
	2,368.421				9,485.8997	
2021	1					
	"		"	"		"
2010	4					
1						
		1,000			60%	40%
	"	"		400		
2						
2010	3	26				
3						
	2014	1		40%		
	"		2014	1		
	"					
2014	1					
			2014	1		40%

2014 5

1

2014 5	2,750	272.2772
3,000	297.0297	1,000
99.0099	" ALD	" " ALD
" "	"	1,010
100		

2

ALD

3

2015 7

" 2015 7 "

2015 7

2015 7	2.8276%	0.9896%	0.9896%	0.8483%
10.10 /				

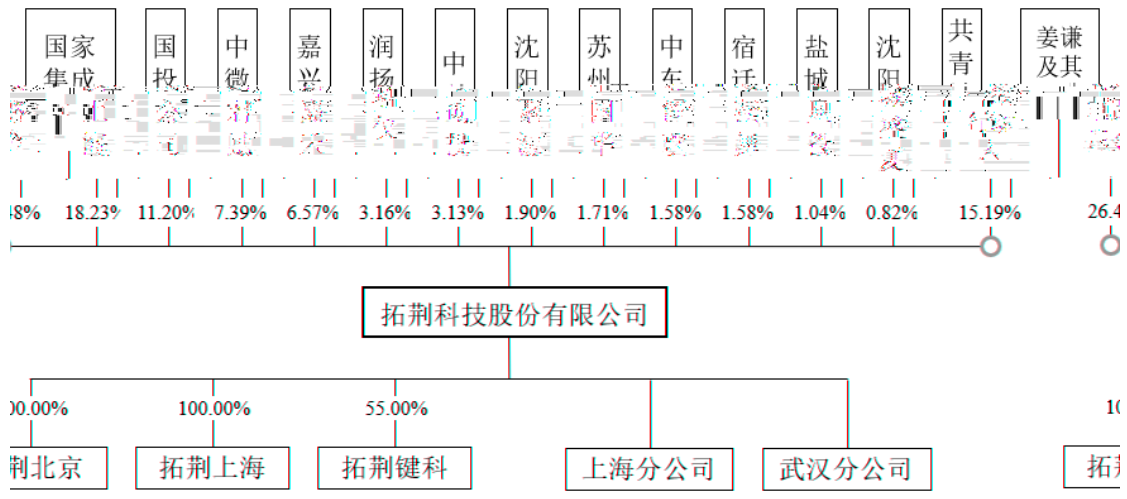

2019 1

1

1

	5,000.00 200.00
	2020 12 11
	16 6 2 217
	100.00%

2

2020.12.31/2020	-	-	-
2021.9.30/2021 1-9	19,091.18	297.31	97.31

2

1

	5,000.00 5000.00
	2020 12 25
	1211 10 304
	100.00%
	" ALD "

2

2020.12.31/2020	-	-	-
2021.9.30/2021 1-9	10,464.88	4,709.90	-290.10

3

1

2020 8 21

2020 9 30

	1,000.00	800.00
	2020	9 30
		8 3
	55.00%	
	20.00%	
	10.00%	
	10.00%	
	5.00%	

2

2020.12.31/2020			
-----------------	--	--	--

2019 1 1 2019 5 5 9
2 2

1 2019 5 6
8 2
2

1

2019 1 1 2021 1 12

2019 1 1 2021 1 12

2 2021 1 12

2021 1 12

2021 1 12

2021 1 12 9

3

6 2

1 2

2021 1 12

2021 1 12

2019 1 1

5%

1

5%

1

2,512.1755

26.4833%

	9,872,000.00
	2014 9 26 2024 9 25
	2 52 7 718

2

1,729.7297

18.2347%

	1,000,000.00

}

	14,220.00
	2018 8 3 2038 8 2
	1856 1 120 -69

	10,000.00
	2018 6 9 2023 6 8
	1002 X 5 6 B

5

623.3158

6.5710%

	13,200.00
	2019 10 14 2027 10 14

/

2021 9

24

36

2019 12 18

/

36

2021 3 30

11

3

" "

"

" "

"

1967	1			28.00
0.2952%		2014	2017	
1942	2			25.5000
0.2688%		2014	2017	
1962	5			17.5000
0.1845%		2014	2020	
1963	1			17.5000
0.1845%		2014	2020	

1950 7

16.00

0.1687%

11

78.7500

0.8302%

	88.9125
	2013 10 18 2028 10 17
	900 401

62.7900

0.6619%

	206.0469
	2013 10 21 2028 10 20
	900 417

23.7450

0.2503%

	27.8569
	2013 10 18 2028 10 17
	900 406

16.8850

0.1780%

	20.2423
	2013 10 18 2028 10 17
	900 419

138.0996

1.4558%

	15.1915
	2019 10 9 2034 10 8

138.0546

1.4554%

	15.1862
	2019 10 9 2034 10 8

138.0416

1.4552%

	15.1848
	2019 10 9 2034 10 8

138.0205

1.4550%

	15.1824
	2019 10 9 2034 10 8

138.0186

1.4550%

	15.1824
	2019 10 9 2034 10 8

137.9725

1.4545%

	15.1770
	2019 10 9 2034 10 8

⑪

137.7926

1.4526%

	15.1577
	2019 10 9 2034 10 8

--	--

2 5%

5%

1

2019 12

19 /

966

18,354

2020 5 20

	/	/		
1			1,380,996	26,238,924.00
2			1,380,416	26,227,904.00
3			1,380,205	26,223,895.00
4			1,380,186	26,223,534.00
5			1,379,725	26,214,775.00
6			689,654	13,103,426.00
7			688,272	13,077,168.00
8			536,842	10,199,998.00
9			516,821	9,819,601.00
10			326,883	6,210,775.00
			9,660,000	183,540,000.00

"

"

2

5%

"

"

"

"

"

"

9,485.8997

3,161.9800

25.00%

			%
1		2,512.1755	26.4833
2		1,729.7297	18.2347
3		1,062.2547	11.1982
4		701.2105	7.3921
5		623.3158	6.5710

			%
6		300.00	3.1626
7		297.0297	3.1313
8		180.0180	1.8977
9		162.1622	1.7095
10-1		150.00	1.5813
10-2		150.00	1.5813

			%	
1		123.4290	1.3012	
2		50.00	0.5271	
3		28.00	0.2952	
4		25.5000	0.2688	
5		17.5000	0.1845	
6		17.5000	0.1845	
7		16.00	0.1687	
8		15.00	0.1581	

1

2021 9 10

[2021]78

			%
1	SS	2,512.1755	26.48

			%
2	SS	297.0297	3.13
3	SS	99.0099	1.04
4	CS	300.00	3.16
		3,208.2151	33.81

2

			%
1		123.4290	1.3012
2		50.00	0.5271
3		28.00	0.2952
4		25.5000	0.2688
5		17.5000	0.1845
6		17.5000	0.1845
7		16.00	0.1687
8		15.00	0.1581
		292.9290	3.0881

	/	%	
1		1.3012	
		0.5271	
		0.2952	

	/	%	
		0.2688	
		0.1687	
		0.1581	
		0.1845	
		0.1845	

	/	%	
5		11.1982	
		0.8212	

1

" "

" "

2

9

			%
1		2,512.18	26.4833
2		1,729.73	18.2347
3		701.2105	7.3921
4		623.3158	6.5710
5		297.0297	3.1313
6		180.018	1.8977
7		162.1622	1.7095
8		150.00	1.5813
9		150.00	1.5813

3

2019 12 16

SJJ396

2015 12 2

P1028590

2019 12

" "

2019

12 31

1

			1981				
	2004		12				
			"		"		
2015	12						
			1979				
MBA	2004	4		2021	3		
						2021	4
			2021	12			
			1979				
			2004	8			
			2017	9			
			1944				1984
3							
			2015	12	2017	9	2021
1							
			1952				
			1997	10			
							2021
1							
			1971				
			1994	7			
	2021		1				
			1979				

2002 8

2021 1

2

			/			
1				2021	1	2024 1
2				2021	4	2024 1
3				2021	1	2024 1
4				2021	1	2024 1
5				2021	1	2024 1
6				2021	1	2024 1

1961

1990

9 2013 9 Nashua Computer Products Western Digital, Santa Clara, CA
NegevTech, Inc. Hitachi High-Technologies America
Honeywell International 2017 8

2021 1

1983

2008 9

2021 4

1982

2008 9

2018 11

1977

1996 12

2021 1

1985

2011 8

2019 11

2019 11 2021 1

2021 1

1974

1998 10 2010 4

2010

4

3

1			2021 1	2024 1	
2			2021 1	2024 1	
3			2021 1	2024 1	
4			2021 1	2024 1	
5			2021 1	2024 1	
6			2021 1	2024 1	

1956

1982 2 2018 2

Codi Semiconductor, Inc.

2018

2

1971

2000

9 2011 2

PECVD ALD

2011 3

1963

A&M

1984 8

2018 10

A&M
Ecovoltz Inc.

Nonometrics Inc. Mattson Technology, Inc. Nonometrics Inc.

2018 11

1971

1993 5 2010 4

2010 4

1968

EMBA

1992 12 2009

9

2010 4

1983

2009 3 2019 11

2019 12

4

7

1			" 90-65nm " " 1x nm 3D NAND PECVD "

2			" 1x nm 3D NAND PECVD " " " A ALD " " A " / ALD SACVD
3			" A ALD " " B PECVD " " A " " / SACVD
4			12 PECVD PF-300T " A ALD " PECVD
5			
6			HTM PECVD 12 ACHM PECVD
7			B PECVD " PECVD "

" "

" "

" " 1 " " 2

" " 3 "

1983

2010 7

2021 12 31

		Advanced Micro-Fabrication Equipment International Pte. Ltd.		
		Advanced Micro-Fabrication Equipment Korea Ltd.		
		PDF Solution Inc.		

COE, NT7Dae9@182G&R&E266Eya

2021 12 31

2019 1 1

9

2019 4 3

2019 11 21

2021 1 8

2021

9

2021 11 24

2021 12 9

2024 1 7

2019 1 1

5

2020 12 11

2021 1 8

2021

2021 4 8

2021 4 30

2024 1 7

2019 1 1

7

2020 5 29

2021 1 8

2014 5 2020

5

2014 9 2020 5

2021 3

7

			/		
			66,600.00	3.23%	60,000
			200,000.00	1.33%	
			6,200,266	1.01%	
		Grenade Pte. Ltd.	174,277		
		Futago Pte. Ltd.	6,875		
			36,300.00	23.91%	330,000
			44,400.00	4.99%	40,000
			12,287.00	8.09%	111,700
			234,190.00	11.37%	49,000
			3,330.00	0.38%	3,000
			44,000.00	28.97%	400,000
			111,000.00	12.48%	100,000
			84,150.00	55.43%	765,000
			155,400.00	17.48%	140,000
			27,500.00	18.11%	250,000
			404,000.00	19.61%	40,000
			4,900.00	98.00%	
			33,110.00	21.80%	301,000
			30,183.00	19.91%	274,386
			14.00	0.01%	126
			14.00	0.01%	126
			557,840.00	27.07%	94,000
			11,000.00	3.95%	
			14,219.00	1.60%	2,900
			4,900.00	98.00%	
			39,963.00	26.31%	363,300
			13,984.00	9.21%	127,126

			/		
			14.00	0.01%	126
			14.00	0.01%	125
			14.00	0.01%	125
			90,687.00	10.20%	81,700
			22,189.00	10.96%	10,080
			11,000.00	0.53%	
			6,600.00	4.35%	60,000
			29,219.00	19.24%	265,630
			309,915.00	15.04%	36,230
			18,870.00	6.77%	17,000

4,000

1.10

1.10

	/					
		500,000	655,000	1,155,000	1.2176%	630,000

	/					
		1,234,290	983,900	2,218,190	2.3384%	883,900
			446	446	0.0005%	
			110,868	110,868	0.1169%	
			370,000	370,000	0.3901%	330,000
			163,700	163,700	0.1726%	111,700
			500,000	500,000	0.5271%	400,000
		150,000	905,000	1,055,000	1.1122%	765,000
			290,000	290,000	0.3057%	250,000
			672,538	672,538	0.7090%	575,638
			582,582	582,582	0.6142%	490,802
			60,000	60,000	0.0633%	60,000
			318,860	318,860	0.3361%	265,630

2022 3 8

446

2021

9 30

615,091,572

6,200,266

1.0080%
0.0357%

Grenade Pte. Ltd. Futago Pte. Ltd.
1.0437%

110,868

7

1

	2021 1-9	2020	2019	2018
	696.66	1,350.10	980.84	884.00
	5,738.27	-1,169.99	-1,936.64	-10,322.29
	12.14%	-	-	-

2

2020

			2020
1			219.14
2			59.34
3			-
4			-
5			-
6			-
7			-
8			-
9			-

			2020
10			173.22
11			-
12			-
13			-
14			-
15			37.59
16			241.78
17			190.78
18			197.54
19			64.32
20			64.26
21			62.00
22			40.13
			1,350.10

2020

2020

1

1

15.1920%

1-1-96

1			500,000	655,000	1,155,000
2			-	883,900	883,900
3			280,000	140,000	420,000
4			255,000	150,000	405,000
5			175,000	175,000	350,000

6

2

11

11 " "

3

	2020 4
	/

1,326,020

1

2

692.92 72.76 192.96 198.25

3

1

	2021.9.30	2020.12.31	2019.12.31	2018.12.31
	429	316	273	278

2

2021 9 30 429

	189	44.06%
	129	30.07%
	36	8.39%

	10	2.33%
	41	9.56%
	14	3.26%
	10	2.33%
	429	100.00%

3

2021 9 30

	135	31.47%
	201	46.85%
	85	19.81%
	8	1.86%
	429	100.00%

4

2021 9 30

51	16	3.73%
41 50	41	9.56%
31 40	166	38.69%
30	206	48.02%
	429	100.00%

1

2

/%

	2021.9.30		2020.12.31		2019.12.31		2018.12.31	
	414	96.50	295	93.35	259	94.87	264	94.96
	66	15.38	46	14.56	41	15.02	33	11.87
	15	3.50	21	6.65	14	5.13	14	5.04
	3	0.70	8	2.53	0	0.00	0	0.00
	1	0.23	1	0.32	2	0.73	2	0.72
	9	2.10	11	3.48	10	3.66	10	3.60
	2	0.47	1	0.32	2	0.73	2	0.72
	429	100.00	316	100.00	273	100.00	278	100.00

3

	2021 9	2020	2019	2018
	6	6	4	1

1

ALD
14nm
SACVD
PECVD
10nm

64/128 3D NAND FLASH
DRAM FLASH
Lok Lok ACHM ADC
PECVD
28/14nm 19/17nm DRAM
PECVD

2

PECVD ALD SACVD

3D

40

6

3nm FinFET

20

90nm CMOS

100

1 PECVD

PECVD

CVD

PECVD

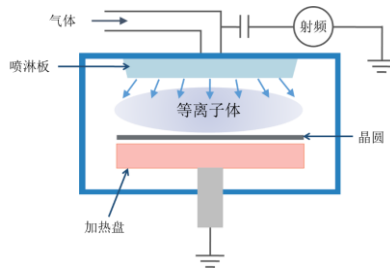

PECVD

180-14nm

19/17nm DRAM 64/128 FLASH

SiO₂ SiN SiON BPSG PSG TEOS Lok Lok ACHM

ADC

2018

PECVD

2020

PECVD

PECVD

			/
12 PECVD PF-300T		PF-300T 28nm FLASH DRAM TSV OLED SiO ₂ SiN SiON BPSG PSG TEOS Lok Lok ACHM ADC	
12 PECVD PF-300T eX		PF-300T eX 14nm-28nm FLASH DRAM SiO ₂ SiN SiON BPSG PSG TEOS Lok Lok ACHM ADC	
12 PECVD PF-300T pX		PF-300T pX 10nm	
8 PECVD PF-200T		PF-200T 90nm 3D TSV SiO ₂ SiN SiON TEOS 12 PECVD	
12 HTM PECVD NF-300H			NF-300H 19nm 32-128 3D NAND FLASH DRAM NF-300H NO stack Thick TEOS

			/
TFLITE		TFLITE SiO ₂ SiN	LED

2 ALD

ALD

ALD

DRAM 3D NAND ALD

ALD

PE-ALD Thermal ALD

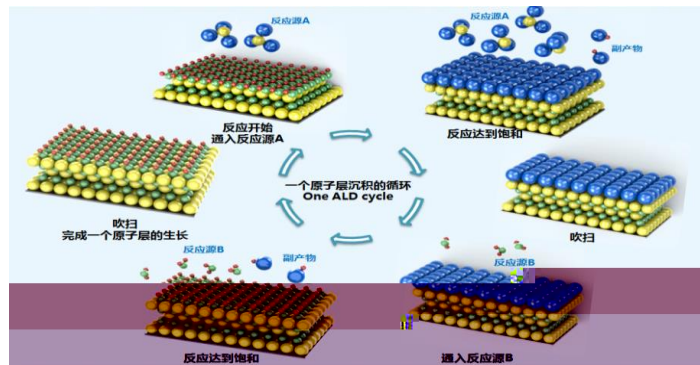

ALD

PE-ALD

PECVD

ALD

ALD

SiO₂ SiN

55-14nm

PE-ALD

28nm

Al₂O₃

AlN

Thermal ALD

ALD

			/
12 PEALD FT-300T		FT-300T PE 28-14nm SADP STI Liner 55-40nm BSI 2.5D 3D TSV FT-300T SiO ₂ SiN	
12 Thermal-ALD FT-300T		FT-300T Thermal 28nm FT-300T Al ₂ O ₃ AlN	
12 ALD FT-300H		FT-300H 128 3D NAND FLASH 19/17 nm DRAM SiO ₂ SiN	

3 SACVD

SACVD

SACVD

Gap fill

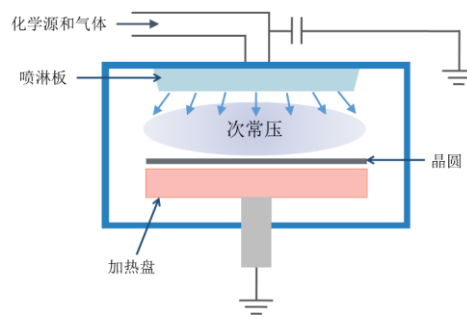

SACVD

SACVD

BPSG SAF

12 40/28nm

8

90nm

SACVD

			/
12 SACVD SA-300T		SA-300T STI ILD BPSG SAF	40-28nm
8 SACVD SA-200T		SA-200T STI ILD BPSG SAF	90nm

3

	2021 1-9		2020		2019		2018	
PECVD	32,283.16	88.69%	41,824.53	97.55%	24,772.45	100%	5,170.28	77.98%
ALD	0.00	0.00%	184.48	0.43%	0.00	0.00%	1,459.58	22.02%
SACVD	4,115.89	11.31%	867.26	2.02%	0.00	0.00%	0.00	0.00%
	36,399.05	100%	42,876.27	100%	24,772.45	100%	6,629.86	100%

PECVD

" " "

" "

Global fundamental limited

"

" " 3

" " 1 " "

Global fundamental limited"

"

" " " "

" 5

"

2010

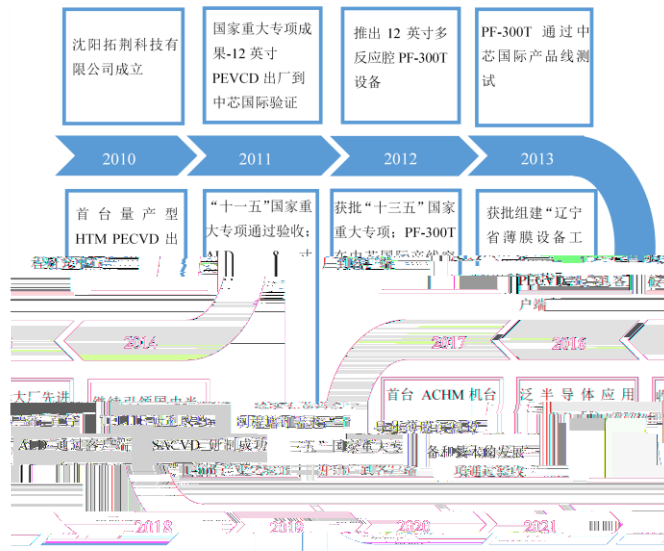

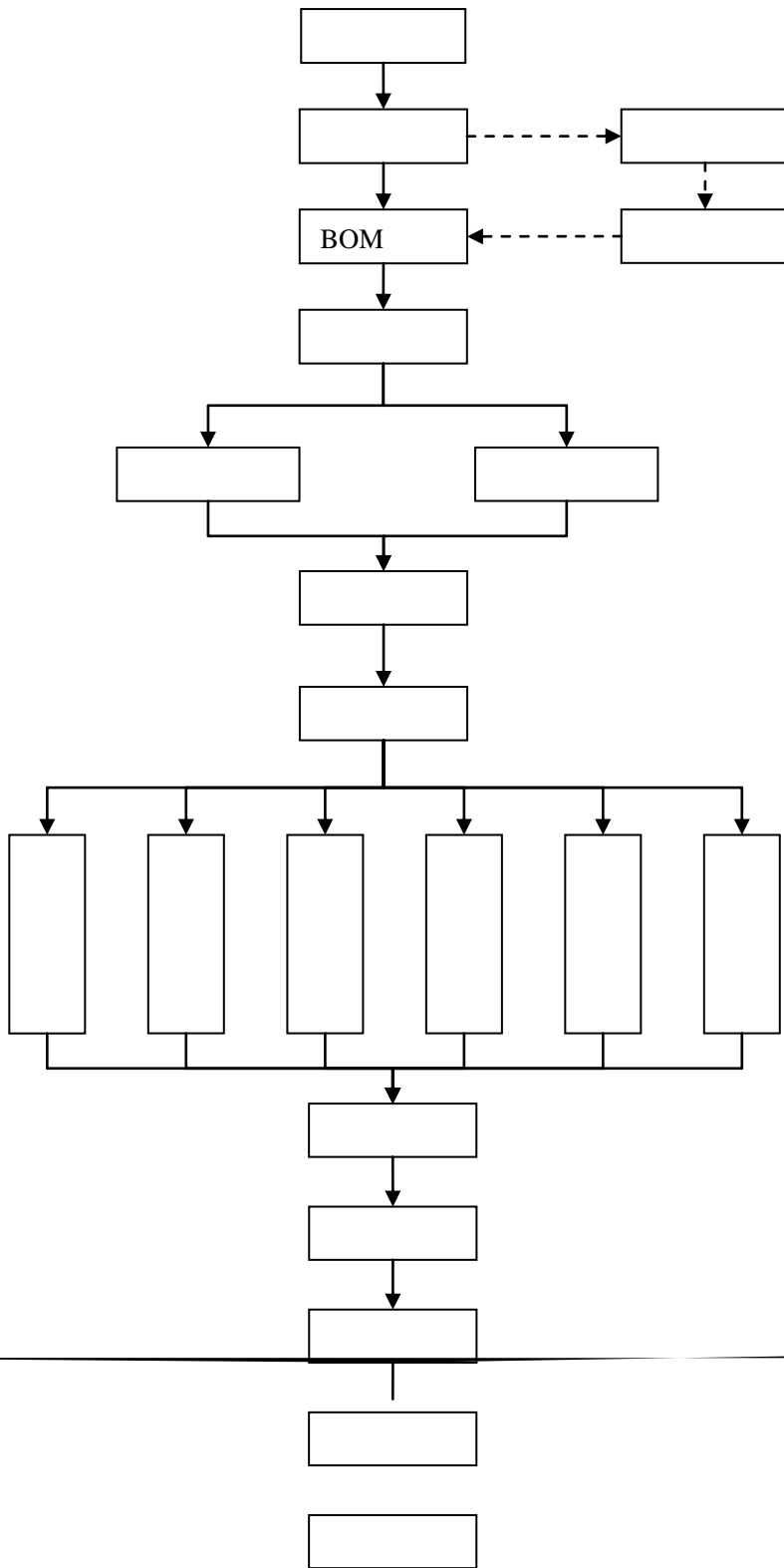

ISO14000

2012

C35

GB/T4754-2017

C3562

2018

1

2

2035	2021		IGBT MEMS
	2020		15 28 15 65 25% 130 10 25%
	2018		2018 1 1 130 10 25% 2018 1 1 65 150 15

			25% "
" "	2017		

3

1

1

integrated circuit 80%

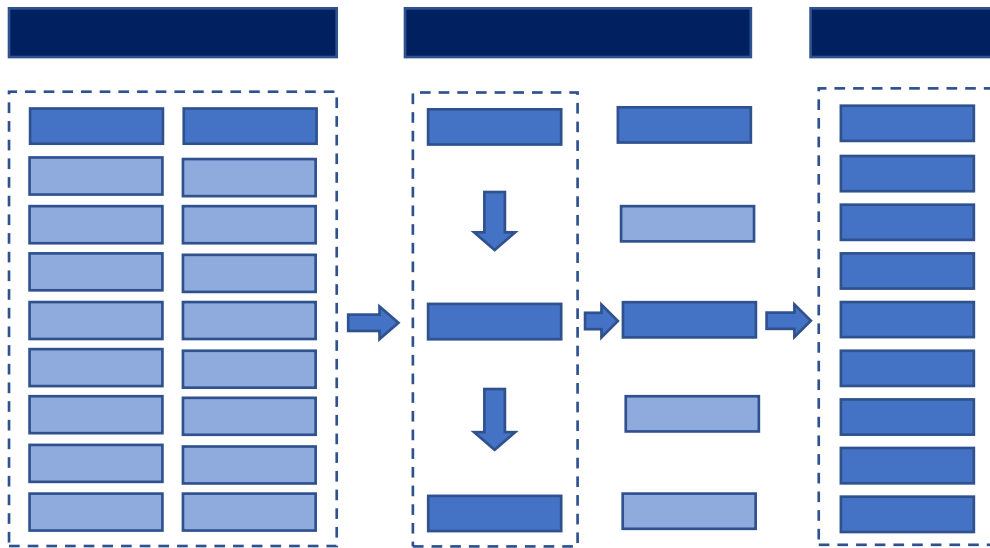

/

CMP

EDA IP

2

Gartner		2016	2018
	17.34%	2019	
	2020	4,498.0	
2019	7.3%	SIA	2021
	1,231	2018	1,227

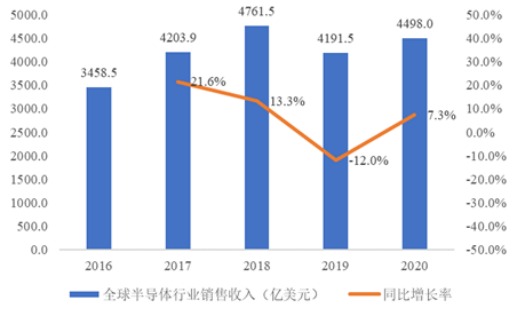

Gartner

SIA 2020

2019

62.50%

35.00%

19.10%

9.70% 8.70%

EDA

"

"

3

2010-2020

19.91%

2020

8,848

17%

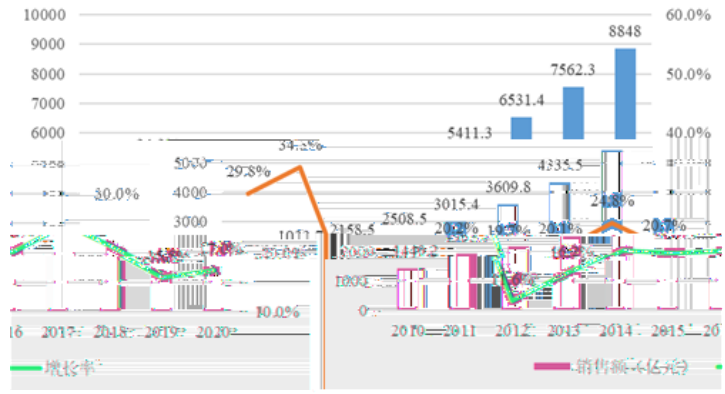

2010

1-2%

4

5G

Gartner 2022

5,426.40

2020



Strategy Analytics

2022

2023

2

1

80%

/

/

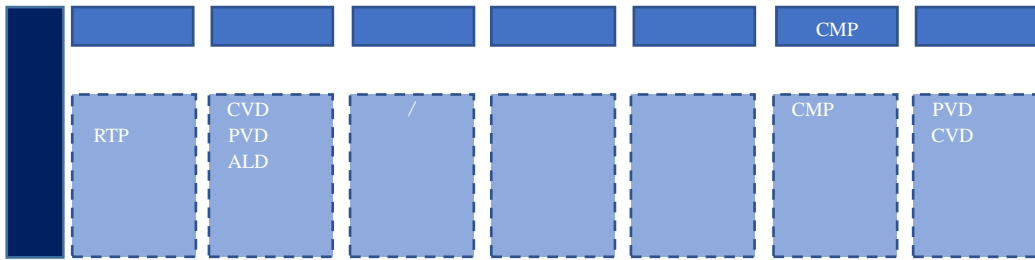

80%

"

"

18-24

2

SEMI

2014

375

2020

712

11.28% 2020

19%

2010-2020



SEMI

AMAT

Lam

TEL

DNS

ASML ASML Holding N.V.

ASMI

3

35%

SEMI

2020

187.2

39%,

2012-2020

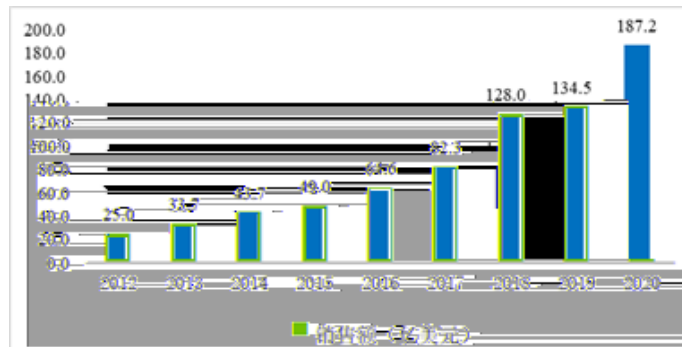

SEMI

28nm

14nm

IDM

2020

213

17.5%

5%

1-2%

3

1

/

ALD

CVD

PVD

PVD CVD ALD

ALD

CVD

PVD

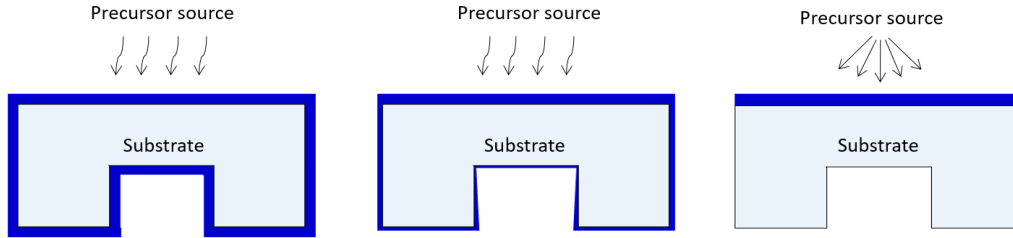

Characterization of Atomic Layer Deposited Thin Films: Conformality in High Aspect Ratio Pores and the Electrical Properties

CVD

CVD

CVD

PECVD SACVD APCVD LPCVD

APCVD

CVD

LPCVD

APCVD

APCVD

PECVD

90nm IC

SACVD

SACVD

400-550

30-600Torr

Gap

fill

ALD

ALD

CVD

ALD

ALD

28nm

28nm

FinFET

Fin

Fin

SADP

Self-Aligned Double Patterning

SADP

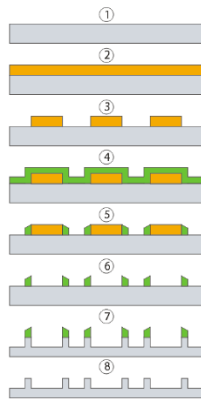

ALD

Spacer

Fin

ALD

k

STI BSI

CMOS

TSV

	Maximize Market Research		2017-2019	
	125	145	155	2020
172		11.2%		

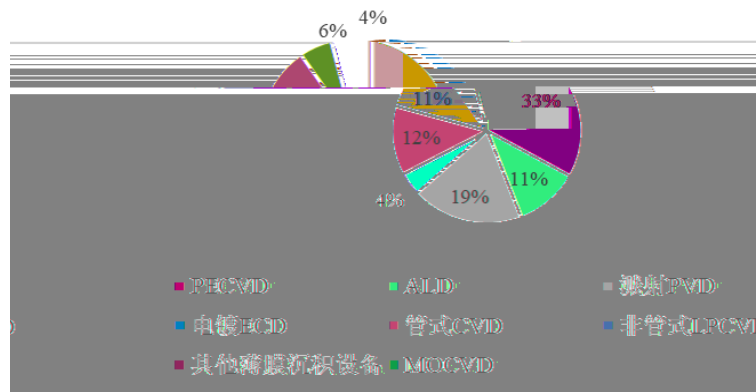

Gartner

Company	Year	Value	Percentage
ALD	2020	32	26.29%
Acumen	2026	172	45.22%
PECVD	2020	14.92	33%
ALD	2020	4.97	11%

Company	Year	Value	Percentage
AMAT	2019	31%	29%
ASMI	ALD	40%	85%
Lam	TEL	30%	70%
TEL	ASMI	21%	19%

全球ALD设备市场占比

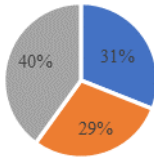

• TEL • ASM • 其他

全球CVD设备市场占比

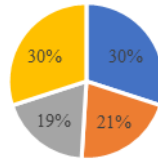

• 应用材料 • 泛林半导体 • TEL • 其他

全球PVD设备市场占比

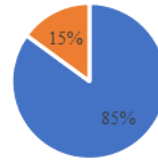

• 应用材料 • 其他

Gartner

3

Maximize Market Research

2025

2020

172

340

13.3%

		/
180nm 8	CVD	9.9
	PVD	4.8
90nm 12	CVD	42
	PVD	24

FLASH 2D NAND 3D

NAND

FLASH 2D 18%

3D 26% 3D NAND FLASH

2D NAND 3D NAND

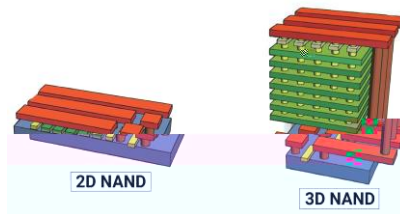

SEMI

1

" 90-65nm

PECVD

"

/

" " 1x nm 3D NAND

2

PECVD ALD SACVD

150

DRAM

3D NAND FLASH

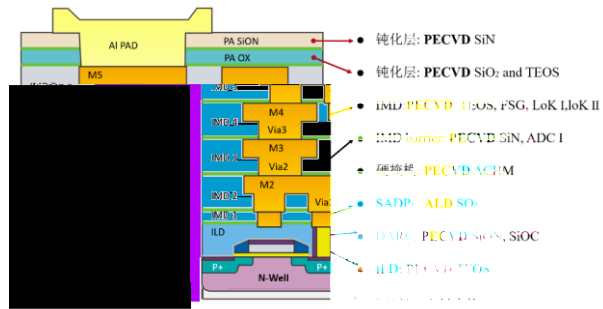

3D NAND

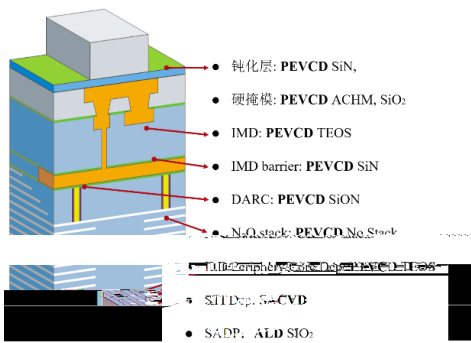

DRAM

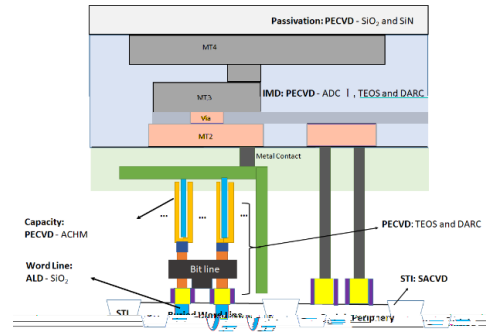

1 PECVD

PECVD

3D

PECVD

16

PECVD

SiO ₂ PECVD		/ Inter Layer Dielectric, Inter Metal Dielectric	130-28nm
		Passivation Layer	14nm 10nm
		Etch hardmask	
SiN PECVD	DRAM FLASH	Etch Stop Layer	130-28nm
		Inter Metal Dielectric	64 FLASH 14nm
		Passivation Layer	128 FLASH 19/17DRAM

SiON PECVD	DRAM FLASH	DARC Dielectric anti-reflective coating layer	
BPSG PECVD		/ Inter Layer Dielectric, Inter Metal Dielectric	
		Passivation Layer	
TEOS PECVD	DRAM FLASH	/ Inter Layer Dielectric, Inter Metal Dielectric	
		Passivation Layer	
		Etch hardmask	
			2.5D 3D
SiOC PECVD		NFDARC Nitrogen free dielectric anti-reflective coating layer	65-28nm

NAND PECVD			
TFLITE	LED	Dielectric / Passivation	4/6
		Patterned Sapphire Substrate Hard Mask/Optical film	

2 ALD

ALD

PE-ALD

Thermal -ALD

SiO ₂ PE-ALD		SADP STI liner	28-14
		TSV	2.5D 3D
	CMOS	BSI	-

3 SACVD

SACVD

SACVD

BPSG SACVD			130-90nm
	DRAM		19/17
SAF SACVD			65-28nm 130nm
SA TEOS SACVD		SAB CAP SMT CAP	40-28nm 130nm

1

2016

2017 2019

"

"

PECVD SACVD

AMAT

Lam

TEL

ASMI

2019-2020

PECVD

16.65%

2020

2020

2

AMAT

Lam

TEL

ASMI

1

AMAT

1967

AMAT

AMAT

LED

15,700

2

Lam

1980

LRCX

Lam
AMAT ASML ASML Holding N.V. 8,200

3 TEL
1963 8035.TYO

TEL

TEL 11,000

4 ASMI
1968

ASM

ALD

PEALD

ASMI

3%

29%

TEL

31%

ASMI

2,500

3

PECVD ALD SACVD

AMAT

Lam

TEL

ASMI

	2018	167.05	45.00%	30.38
	2019	146.08	43.72%	27.06
	2020	172.02	44.72%	36.19
	2018	110.77	46.63%	23.81
	2019	96.54	45.15%	21.91
	2020	100.45	45.88%	22.52
	2018	11,307.28	42.01%	2043.99
	2019	12,782.40	41.94%	2482.28
	2020	11,272.86	40.09%	1852.06
	2018	8.18	40.90%	1.57
	2019	12.84	49.73%	3.29
	2020	13.28	46.95%	2.85

Wind

11 - 10 Lam AMAT
 TEL 4 - 3 ASMI 1 - 12

4

PECVD ALD SACVD

WPH	
Uptime	
MTBF	
MWBB	

MTTR	

1

1

189

44.06%

2

2022 3 8

174

153

21

98

77

21

" 90-65nm

"

" 1x nm 3D NAND PECVD

"

4

/

PECVD ALD SACVD

3

"

"

2016 2017 2019

"

"

PECVD ALD SACVD

4

5

2

1



2

1

1

2

7

NAND

3D NAND

32/64

128/196

3

2010

2020

19.91%

2020

187.2

4

2

1

2

1

		2021	1-9	2020	2019	2018
		0		0	0	1
		0.00%		0.00%	0.00%	
SACVD		3		3	1	0
		1		1	0	0
		33.33%		33.33%	0.00%	0.00%

1 TM

PM

100%

2

"

" "

" "

" " 2

"

2020

ALD

2020

ALD

2018

ALD

3

PECVD	
ALD	ICRD
SACVD	

4

"

" "

" "

"

5

"

" "

" "

"

1

2021 1-9	1		10,484.54	28.80%
	2		10,231.40	28.11%
	3		6,109.99	16.79%
	4		3,598.00	9.88%
	5		3,221.87	8.85%
			33,645.79	92.44%
2020	1		19,608.70	45.73%
	2		8,218.48	19.17%
	3		4,629.22	10.80%
	4		1,895.99	4.42%
	5		1,570.12	3.66%
			35,922.51	83.78%
2019	1		6,710.00	27.09%
	2		5,757.15	23.24%
	3		4,100.00	16.55%
	4		2,873.60	11.60%
	5		1,373.15	5.54%
			20,813.90	84.02%
2018	1		2,694.44	40.64%
	2		1,494.84	22.55%

	3		1,459.58	22.02%
	4		981.00	14.80%
			6,629.86	100.00%

1

Global fundamental limited

2

3

2

50%

100.00% 84.02% 83.78% 92.44%

1

IC Insights

2021-2025

2020 12

10

300mm

200mm

91% 54%

2018 2020

	2020	2019	2018
	59.65%	67.51%	60.55%

	2020	2019	2018
	54.33%	45.61%	57.07%
	83.36%	87.33%	92.49%
	85.71%	94.06%	99.09%
	70.76%	73.63%	77.30%
	83.78%	84.02%	100.00%

2021 1-9

2

10,000

			IC Insights	2020
				4
				1
		01347	IC Insights	2020
			5	2
			2020 NAND	1%
			7	1

CFM

Chipinsights

3

	2011 12 PECVD 2013 2014 PF-300T	2018 2020 IPO 733,016	
	2017 6 ICRD 2019	2018 2020 155nm 1 2019 25	
	2015 2016	2018 2020 20 / 2020	

4

2017 9 6

2018 6

2018 9 6

2018 1 1 2018 9 6

2018 9 6

3

1

ICRD

ICRD

		2021 1-9	2020	2019	2018
		-	2,200.00	-	700.00
		-	4,629.22	-	1,459.58

ICRD

ICRD

ICRD

2002

IP

ICRD

ICRD

ICRD

ACHM Lok ADC

ICRD

ICRD

ICRD

Global fundamental limited

Global fundamental limited

Global fundamental limited

		2021 1-9	2020	2019	2018
		970.51	367.15	178.05	74.32
		-	1,496.15	5,757.15	-

2016

" 90-65nm

"

2017

Global fundamental limited

2017

2017 11

③

"

" "

" "

" " 1

"

2

			2021 1-9	2020	2019	2018
			1,393.81	821.20	307.05	87.30

			2021 1-9	2020	2019	2018
			30.01	870.60	-	-
			5.23	2.83	4.58	15.41
			10,686.55	19,985.19	6,834.70	1,106.16

1

1

1		
2		IO
3		EFEM
4		
5		LDS
6		
7		
8		

9		
10		
11		

	2021 1-9		2020		2019		2018	
	19,733.70	28.20%	11,882.05	25.29%	5,591.00	27.69%	4,395.79	23.00%
	19,185.40	27.42%	11,343.25	24.14%	5,129.39	25.40%	4,747.43	24.84%
	8,357.90	11.94%	7,698.45	16.38%	3,270.08	16.19%	2,485.16	13.00%
	5,712.30	8.16%	3,522.71	7.50%	1,775.99	8.79%	1,280.83	6.70%
	5,117.55	7.31%	3,226.29	6.87%	1,209.23	5.99%	1,079.20	5.65%
	3,115.62	4.45%	3,163.55	6.73%	873.58	4.33%	1,652.58	8.65%
	3,668.89	5.24%	2,975.07	6.33%	934.60	4.63%	1,435.61	7.51%
	849.81	1.21%	1,209.56	2.57%	94.39	0.47%	671.12	3.51%
	1,282.26	1.83%	860.49	1.83%	664.21	3.29%	786.93	4.12%
	838.31	1.20%	545.38	1.16%	255.23	1.26%	128.97	0.67%
	2,116.62	3.02%	562.43	1.20%	396.78	1.96%	446.61	2.34%
	69,978.35	100.00%	46,989.23	100.00%	20,194.48	100.00%	19,110.23	100.00%

2019

2018 5.67%

2019

2018

2018

demo

2018

demo

2018

2018

2019

2018

2

		2021 1-9	2020	2019	2018
		99.91	100.43	99.04	100.00
		81.40	94.08	96.88	100.00
		82.95	88.95	100.26	100.00
		64.73	83.53	91.09	100.00
		75.53	81.56	90.66	100.00
		96.19	98.17	102.63	100.00
		74.40	89.61	89.84	100.00
		100.25	112.16	100.58	100.00
	A	83.18	94.73	101.44	100.00
		81.66	101.77	96.94	100.00



2018	1	XP POWER LLC		2,171.30	11.36%
	2			1,481.76	7.75%
	3			1,282.68	6.71%
	4	Rorze Corporation		1,256.28	6.57%
	5	Ferrotec		1,196.70	6.26%
				7,388.72	38.66%

Ferrotec
 2020
 Ferrotec XP POWER LLC XP POWER
 LLC Comdel Beijing Customer Support LLC ⑤Rorze Corporation Rorze Corporation
 2020 3 12
 2021 1-9

1

			PECVD	ALD
				SACVD

1
2

			PECVD	ALD	SACVD
	10 7				

3

2

1

ADC k k Lok Lok
 ACHM 3D NAND ONON

k

ADC

ACHM

3D NAND

/

2

PECVD

ALD

SACVD

6

18

3

EFEM

LOADLOCK

Transfer Module

/

EFEM

4

PECVD ALD

10

5

6

IC

3

	2021	1-9	2020	2019	2018	
	36,399.05		42,876.27	24,772.45	6,629.86	110,677.63
	37,389.57		43,562.77	25,125.15	7,064.40	113,141.89
	97.35%		98.42%	98.60%	93.85%	97.82%

93.85%

98.60% 98.42% 97.35%

97.82%

4

1

2

3

1

1		-6	CC1-150	2011
2		-12	PECVD	2014
3				2017
4				2017
5		2019		2019
6				2017
7		2016		2017
8		2016		2017
9		2017		2018
10		2019		2020
11				2019
12				2021

2

1	90-65nm			2008.12 2016.6	35,763.02	
2	1x nm 3D NAND PECVD			2016.1 2020.12	52,290.83	
3	1x nm 3D NAND PECVD			2019.1 2020.6	7,012.77	
4	A ALD			2020.1 2021.12	10,016	
5	B PECVD			2020.1 2021.12	18,013	

6	A	-	-	-	-	-
7	B	-	-	-	-	-

1 PECVD

40nm	ADC Lok Lok 40nm ACHM PECVD				1,538
28nm-14nm	DARC HTN PECVD SiO ₂ a-Si SiN TEOS				7,130
10nm	10nm PECVD				6,593
28nm	1 2				36,014

					994
TF-Lite	4/6	LED SiO ₂ PECVD			291
12 HDPCV D	12	PECVD			3,806

2 ALD

ALD HTM SiO ₂	NAND	128 3D SiO ₂ ALD			10,016
28nm Thermal ALD AlOx		28nm Thermal ALD AlOx			3,860

3 SACVD

	28nm 5:1				1,140

1

	2021 1-9	2020	2019	2018
	12,955.63	12,278.18	7,431.87	10,797.31
	37,389.57	43,562.77	25,125.15	7,064.40
	34.65%	28.19%	29.58%	152.84%

10,797.31 7,431.87 12,278.18

12,955.63 152.84% 29.58% 28.19% 34.65%

2018 100%

2

"

" " " " " " 3

"

1		ACHM 3D		
2		PECVD		
3		3D NAND PECVD		

4		ALD A		
5		B PECVD		

1

2021 9 30

189

44.06%

2

"

"

"

"

3

5

"

" "



"

4

1

1

2

3

2

10

28

128 3D NAND

1Y DRAM

LED

TSV

2.5D-IC 3D-IC

	14,107.99	3,185.65	-	10,922.33	77.42%
	8,331.99	3,414.35	-	4,917.65	59.02%
	22,439.98	6,600.00	-	15,839.98	70.59%

1

900

38,065.39

" 1 "

2

	1	37,031,114.33	23,838,779.84	64.37%
	1	20,142,310.26	12,966,612.22	64.37%
	1	1,538,461.51	1,136,538.45	73.88%
	1	1,187,711.56	538,901.66	45.37%
	4	59,899,597.66	38,480,832.17	64.24%

3

2022 3 8

24

" 2

"

1

2022 3 8

1	900		2015 011	52,107.19			2064.11.17	

2

2022

3 8

22

10

2

3

3

2022 3 8

174

153

77

75

1

21

17

4

98

"

4

"

"

"

" 90-65nm

"

" 1x nm 3D NAND

PECVD

"

4

2022 3 8

5

1		sypiotech.cn	2010.03.04-2023.03.04
2		.cn	2015.09.30-2025.09.30
3		.com	2015.09.30-2025.09.30

GR202121001035

2021 12 14

2016 32

SEMI S2

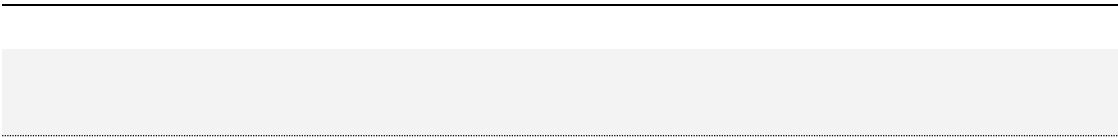

1

2021 1 8

2021

2

2022 3 8

5

1

2021 1 8

2021



9

1

3

2

3

18

2022 3 8

7

1

2021 1 8

2021

3

6

2

2

2

2022 3 8

4

1

2021 1 8

2

2021 1 8

3

2021 1 8

2022 3 8

1

SAP PLM OA

2020 7

SAP

2021 1 6

PLM

2021 9 2

OA

2021 11 2

OA

OA

2022 1 4

[2022]9

2021 9 30

5%

5%

5%



5%

5%

5%

5%

5%

5%

5%

5%

2



5%

" " " " " 5
" "

36

1

5%

5%

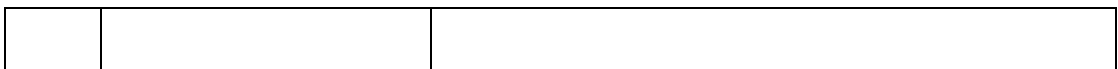

1

26.48%

3		11.20%
4		7.39% 8.97%
5		8.97% 1.58%
6		6.57%
7		15.1920%

5%

5%

2

5%

2021 12 31

5%

1		100.00%
2		100.00%
3		100.00%
4		100.00%
5		100.00%
6		100.00%
7		100.00%
8		100.00%
9	AMEC North America, Inc.	100.00%
10	AMEC Japan Co., Inc.	100.00%
11	Advanced Micro-Fabrication Equipment Korea Ltd.	100.00%
12	Advanced Micro-Fabrication Equipment International Pte. Ltd.	100.00%

13		95.00%

3

"

" "

" "

"

4

18

"

" "

" "

"

5

"

" "

"

1		
2		
3		

4		
5		
6		
7		
8		
9		
10		
11		
12		
13		
14		
15		

6

	/	
1		

	/	
10		2017 1 1 2017 9 6
11		2017 1 1 2017 9 6
12		2017 9 6 2017 11 15
13		2017 11 15 2019 4 3
14		2017 1 1 2017 9 6
15		2017 1 1 2017 9 6
16		2017 9 6 2018 11 28
17		2017 1 1 2017 8 9 6.72%
18		2021 1
19		2020 2
20	ACM Research, Inc.	2021 5
21		2021 11 15
22		5%
23		2020 7
24		2020 9
25		2020 9
26		2021 8
27		2021 7
28		2020 10 30
29		2020 11 4
30		2020 11 4
31		
32		
33		

	/	
34		
35	Solayer GmbH	
36		2019 10
37		
38		2021 9
39		2001 2022 5 3 8
40		
41		
42		2021 4
43		
44		2020 1
45		2020 3
46		2019 12
47		2019 12 12 2019 12
48		2019 12 2018 11
49		2019 11
50		2019 2021 9 11 17
51		2018 11 21
52		2019 11
53		2017 3 2017 3
54		
55		
56		

	/	
57		2021 1
58		
59		
60		
61		2021 10 15
62		2021 6
63		
64		
65		
66		8 2021 11 2019
67		8 2017
68		9 2017
69		2017 8
70		2017 2
71		9 2021 10 2018
72		2019 7
73		2020 1 20
74		2020 6 11
75		2017 8
76		2017 5
77		2017 9
78		11 2017
79		2018 6

	/	
80		2018 3
81		2018 5
82		2018 5
83		2018 6
84		2017 5
85		90.00%
86		
87		2017 9 8
88		2021 6 22
89		
90		2021 4
91		
92		
93		
94		
95		2020 7
96		2019 12
97		2019 12
98		99.00% 2021 7
99		99.00% 2021 7

7

--	--	--

1		20.00%
2		99.70%
3		8.97%
4		
5		98.00%

18

12

12

1

1

		2021 1-9	2020	2019	2018
			33.98	895.55	26.28
					44.20
			33.98	895.55	70.47

		2021	1-9	2020	2019	2018
		37,389.57		43,562.77	25,125.15	7,064.40
				0.08%	3.56%	1.00%

0.00
 2019

70.47 895.55 33.98

1.00% 3.56% 0.08% 0.00%

2019

PECVD

2019 867.70 PECVD

PF-300T

851.20

32.93% 2019

31.99%

2016 2017

PECVD

		2021 1-9	2020	2019	2018
		1,393.81	821.20	307.05	87.30
		25.13	67.02	20.62	10.75
		73.98	191.68	21.32	38.10
		101.95	135.56	149.76	89.88
			38.12	38.12	119.13
		110.49	157.44	52.36	
		7.35	42.83		
		1.60	3.20		
		1,714.31	1,457.06	589.22	345.16
		20,271.00	28,725.47	17,122.39	4,827.04
		8.46%	5.07%	3.44%	7.15%

345.16

589.22 1,457.06 1,714.31 7.15%

3.44% 5.07% 8.46% 2021 1-9

SAP PLM OA

SAP

SAP

2017

2020

3

	2021	1-9	2020	2019	2018
		681.04	1,309.32	1,008.89	968.97

2018 2019 2020 2021 1-9

968.97 1,008.89 1,309.32

681.04

2

1

		2021 1-9	2020	2019	2018
				6.87	
				6.87	
		37,389.57	43,562.77	25,125.15	7,064.40
				0.03%	

2019

6.87

0.03%

2

		2021 1-9	2020	2019	2018
					22.22
					0.27
					22.50
		20,271.00	28,725.47	17,122.39	4,827.04
					0.47%

2018

22.50

0.47%

2018

2018

3

4

5

" " " " "

6

5%

2019 12

2019 11

666 2020 1

2020 1

2019 11

592

202.99 2020

3

1		2018-2020	955.81	
2		2018	44.20	
3			2,609.36	
4			123.52	
5			325.08	
6			477.15	
7		2018-2020	195.38	SAP PLM OA
8		2019-2020 2021 1-9	320.29	
9		2020 2021 1-9	50.18	
10		2020 2021 1-9	4.80	
11			3,968.22	
12		2019	6.87	
13		2018	22.22	
14		2018	0.27	
15		2020	-	
16		2019-2020	666.00	
17		2019-2020	592.00	
18		2020	202.99	

4

1

		2021.9.30		2020.12.31		2019.12.31		2018.12.31	
		-	-	24.00	0.24	110.94	1.11	30.48	0.30
		110.49	-	-	-	-	-	-	-
		110.49	-	24.00	0.24	110.94	1.11	30.48	0.30

110.49

PLM

2

		2021.9.30	2020.12.31	2019.12.31	2018.12.31
		892.64	744.81	258.98	52.92
		60.94	61.31	14.00	5.60
		88.00	40.88	18.91	14.94
					70.00
			15.85	16.80	
		1,041.57	862.85	308.68	143.46
		773.93	463.30	55.84	
		773.93	463.30	55.84	
				592.00	
				666.00	
				1,258.00	

5

5%

5

2021 1-3 2021 6 15 2021 5 21
2018 2019 2020
2018 2019 2020
2021 1-3
2021 5 21 2020
2021 6 15
2020
2021 1-9

"

2018 2019 2020 2021 1-9

"

1

"

" "

"

2

18

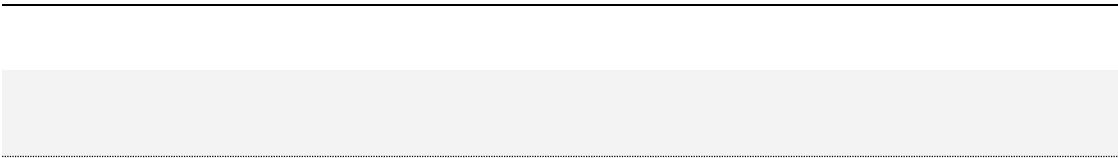

[2022]8

688037.SH

688082.SH

688012.SH

A20569.SH

	2021 9 30	2020 12 31	2019 12 31	2018 12 31
	2,036,851,077.21	1,609,043,018.11	856,558,704.83	694,256,886.02
	-	-	-	60,000.00
	158,399,773.79	164,695,319.27	177,830,871.35	191,018,140.79
	100,393,409.29	-	-	-
	1,678,825.64			
	36,763,420.62	38,198,406.02	39,727,298.01	40,846,594.41
	1,403,005.80			
	9,809,405.36	2,132,350.00	-	264,000.00
	308,447,840.50	205,026,075.29	217,558,169.36	232,188,735.20
	2,345,298,917.71	1,814,069,093.40	1,074,116,874.19	926,445,621.22
	-	-	-	30,156,652.33
	120,866,654.75	91,586,184.48	36,229,223.78	29,175,678.80
	264,405,225.33	122,425,061.53	82,393,615.66	60,930,817.87
	-	-	56,002,078.20	46,842,000.00
	445,141,643.61	134,257,091.68	-	-
	18,736,136.28	22,424,587.97	11,081,991.19	6,716,786.32
	4,874,519.66	5,058,751.10	2,198,791.25	1,801,265.25
	47,757.74	340,940.94	13,206,424.83	178,757.43
	610,426.38			
	57,866,914.13	17,453,421.92	-	-
	912,549,277.88	393,546,039.62	201,112,124.91	175,801,958.00
	-	-	-	350,985.49
	895,046.38			
	35,347,581.23	27,619,567.44	12,504,894.76	3,844,737.99
	216,231,057.13	270,404,740.53	46,230,297.49	52,294,434.29

	2021 9 30	2020 12 31	2019 12 31	2018 12 31
	834.23			
	252,474,518.97	298,024,307.97	58,735,192.25	56,490,157.77
	1,165,023,796.85	691,570,347.59	259,847,317.16	232,292,115.77
	94,858,997.00	94,858,997.00	78,411,628.50	71,174,787.00
	1,001,575,585.12	1,280,812,453.49	977,830,688.99	845,585,030.67
	-	1,303,267.08	1,303,267.08	1,303,267.08
	84,466,514.33	-254,765,043.20	-243,276,027.54	-223,909,579.30
	1,180,901,096.45	1,122,209,674.37	814,269,557.03	694,153,505.45
	-625,975.59	289,071.44	-	-
	1,180,275,120.86	1,122,498,745.81	814,269,557.03	694,153,505.45
	2,345,298,917.71	1,814,069,093.40	1,074,116,874.19	926,445,621.22

	2021 1-9	2020	2019	2018
	373,895,652.48	435,627,676.17	251,251,546.85	70,644,026.75
	202,710,018.66	287,254,727.29	171,223,934.80	48,270,366.35
	4,761,891.55	2,185,328.84	2,195,898.70	2,110,727.48
	52,939,055.57	66,354,085.59	46,976,512.91	40,257,517.58
	23,478,596.10	27,932,438.64	21,442,074.96	22,504,724.76
	129,556,328.43	122,781,824.63	74,318,715.86	107,973,139.03
	-15,180,671.38	-10,358,884.67	-3,314,987.71	-3,163,711.40
	80,832,808.55	51,033,846.90	43,328,955.34	46,970,517.70
" "	-1,771,862.93	-5,209,649.49	-148,999.15	-2,882,623.31
" "	1,592,798.90	945,595.60	-964,609.54	-

	2021 1-9	2020	2019	2018
" "	-12,968.60	-4,771.48	-	-7,390.19
" -"	56,271,209.47	-13,756,822.62	-19,375,256.02	-103,228,232.85
	1,111,524.30	2,072,507.32	39,404.58	5,347.47
	-	15,628.92	30,596.80	-
" -"	57,382,733.77	-11,699,944.22	-19,366,448.24	-103,222,885.38
	333,999.92		-	-
" -"	57,048,733.85	-11,699,944.22	-19,366,448.24	-103,222,885.38

57,963,780.88

" -"

	2021 1-9	2020	2019	2018
	2,200,766.10	2,570,145.66	1,838,195.92	40,011,866.33
	68,748,599.67	266,527,927.41	52,444,955.35	58,821,309.89
	785,578,382.10	909,461,629.80	273,044,388.39	213,339,166.00
	686,685,832.40	449,693,393.12	197,726,377.65	236,470,097.26
	91,135,201.95	72,577,425.41	64,185,926.06	59,785,822.15
	23,491,670.02	16,001,266.45	2,142,907.11	4,148,143.14
	60,238,425.78	62,276,839.83	30,745,230.35	40,950,269.79
	861,551,130.15	600,548,924.81	294,800,441.17	341,354,332.34
	-75,972,748.05	308,912,704.99	-21,756,052.78	-128,015,166.34
	-	-	-	-
	-	-	-	-
	1,150.00	467,983.21	-	1,896.55
	-	-	-	2,854,143.82
	1,150.00	467,983.21	-	2,856,040.37
	104,273,447.26	6,310,245.86	14,374,680.43	5,565,720.23
	-	-	-	-
	-	-	-	-

	2021 1-9	2020	2019	2018
	104,273,447.26	6,310,245.86	14,374,680.43	5,565,720.23
	-104,272,297.26	-5,842,262.65	-14,374,680.43	-2,709,679.86
	-	313,000,002.00	137,499,998.00	-
	-	-	15,320,668.36	33,324,791.81
	-	-	12,580,000.00	-
	-	313,000,002.00	165,400,666.36	33,324,791.81
	-	-	45,584,783.87	76,428,787.18
	-	-	638,090.78	2,183,166.15
			-	-
	3,595,567.76	10,550,091.27	-	-
	3,595,567.76	10,550,091.27	46,222,874.65	78,611,953.33
	-3,595,567.76	302,449,910.73	119,177,791.71	-45,287,161.52
	378,682.36	-1,193,818.66	-	-
	-183,461,930.71	604,326,534.41	83,047,058.50	-176,012,007.72
	949,780,236.54	345,453,702.13	262,406,643.63	438,418,651.35
	766,318,305.83	949,780,236.54	345,453,702.13	262,406,643.63

	2021 9 30	2020 12 31	2019 12 31	2018 12 31
	719,310,598.80	948,649,686.56	362,168,782.00	275,452,133.79
	3,500,000.00	-	400,000.00	-
	123,000,449.23	73,822,594.48	131,388,588.66	62,719,948.71
	43,080,636.68	3,681,029.76	2,077,991.38	2,782,662.47
	58,436,685.59	2,864,502.56	3,069,298.49	14,994,004.70
	973,696,056.95	512,080,385.24	349,976,861.13	322,327,688.24
	2,648,200.50	2,648,200.50	-	-
	1,823,580.00	535,590.00	-	-
	67,421,255.58	11,038,579.86	7,477,183.17	15,980,448.11
	1,992,917,463.33	1,555,320,568.96	856,558,704.83	694,256,886.02
	-	-	-	60,000.00
	57,500,000.00	5,500,000.00	-	-
	157,488,478.62	164,682,844.14	177,830,871.35	191,018,140.79
	36,247,186.30			
	36,763,420.62	38,198,406.02	39,727,298.01	40,846,594.41
	-	-	-	-
	9,498,105.36	2,132,350.00	-	264,000.00
	297,497,190.90	210,513,600.16	217,558,169.36	232,188,735.20
	2,290,414,654.23	1,765,834,169.12	1,074,116,874.19	926,445,621.22
	-	-	-	30,156,652.33
	120,866,654.75	91,586,184.48	36,229,223.78	29,175,678.80



	2021 1-9	2020	2019	2018
	44,226,625.03	66,354,085.59	46,976,512.91	40,257,517.58
	22,433,663.12	27,750,314.24	21,442,074.96	22,504,724.76
	121,923,765.23	120,164,551.48	74,318,715.86	107,973,139.03
	-15,028,130.17	-10,356,614.01	-3,314,987.71	-3,163,711.40
	77,981,665.47	48,915,306.00	43,328,955.34	46,970,517.70
" "	-1,716,740.90	-5,209,649.49	-148,999.15	-2,882,623.31
" "	1,058,405.86	927,505.16	-964,609.54	-
" "	-12,968.60	-4,771.48	-	-7,390.19
" -"	60,545,889.70	-12,932,612.38	-19,375,256.02	-103,228,232.85

	2021 1-9	2020	2019	2018
	84,489,040.08	72,153,895.09	64,185,926.06	59,785,822.15
	22,505,242.49	16,000,516.45	2,142,907.11	4,148,143.14
	57,463,573.71	62,053,475.89	30,745,230.35	40,950,269.79
	846,414,785.95	599,906,608.37	294,800,441.17	341,354,332.34
	-63,117,752.40	259,552,425.77	-21,756,052.78	-128,015,166.34
	-	-	-	-
	-	-	-	-
	1,150.00	467,983.21	-	1,896.55
	5,860.42	-	-	2,854,143.82
	7,010.42	467,983.21	-	2,856,040.37
	41,256,493.30	6,297,770.73	14,374,680.43	5,565,720.23
	52,000,000.00	5,500,000.00	-	-
	55,000,000.00	-	-	-
	148,256,493.30	11,797,770.73	14,374,680.43	5,565,720.23
	-148,249,482.88	-11,329,787.52	-14,374,680.43	-2,709,679.86
	-	312,500,002.00	137,499,998.00	-

	2021 1-9	2020	2019	2018
	-	-	15,320,668.36	33,324,791.81
	-	-	12,580,000.00	-
	-	312,500,002.00	165,400,666.36	33,324,791.81
	-	-	45,584,783.87	76,428,787.18
4b EnFP	-	-	638,090.78	2,183,166.15
	3,120,000.00	10,550,091.27	-	-
	3,120,000.00	10,550,091.27	46,222,874.65	78,611,953.33
	-3,120,000.00	301,949,910.73	119,177,791.71	-45,287,161.52
	378,682.36	-1,193,818.66	-	-
	-214,108,552.92	548,978,730.32	83,047,058.50	-176,012,007.72
	894,432,432.45	345,453,702.13	262,406,643.63	438,418,651.35
	680,323,879.53	894,432,432.45	345,453,702.13	262,406,643.63

2020 2021 1-9 2018 2019

1

43,562.77 37,389.57 2019 7,064.40 25,125.15
2020
255.66% 73.38%

1 2018 2019

2 2020 2021 1-9

2

		33,052.11	35,782.99
52,381.17	99,031.84	819.34	785.31
1,173.13	1,193.01	32,232.77	34,997.69
51,208.04	97,838.83		

0.5%

0.5%

"

"

2014

3

		2	55%	2020 9 30
		2	100%	2020 12 11
		2	100%	2020 12 25

1 2019 2020 2021 1-9

---		12

a

b

	%
6	1.00
7-12	5.00
1-2	15.00
2-3	20.00

	%
3-4	30.00
4-5	50.00
5	100.00

2 2018

1

	200	10%

2

	%	%	%
6	1.00	1.00	1.00
7-12	5.00	5.00	5.00
1-2	15.00	15.00	15.00
2-3	20.00	20.00	20.00
3-4	30.00	30.00	30.00
4-5	50.00	50.00	50.00
5	100.00	100.00	100.00

3

1

2

3

4

5

1

2

			%	%
		20	5	4.75
		3-5	5	31.67-19.00
		5-10	5	19.00-9.50
		4	5	23.75

1

2

	50	
	10	
	5-10	

1 2020 2021 1-9

1

2

3



2 2018

2019

1

a

b

c

d

e

2

1

1



2

2

3

4

1

1

2019 1 1

22 —

—

23 —

24 —

37 —

2019 1 1

2019 1 1

	2018 12 31		2019 1 1
	275,452,133.79	4,642,800.00	280,094,933.79
	14,994,004.70	-4,642,800.00	10,351,204.70
	30,156,652.33	43,826.43	30,200,478.76
	178,757.43	-43,826.43	134,931.00

2

2020 1 1

14

2020 1 1

2020 1 1

	2019 12 31		2020 1 1
	131,388,588.66	-14,093,432.41	117,295,156.25
	-	13,557,842.41	13,557,842.41
	-	535,590.00	535,590.00
	56,002,078.20	-56,002,078.20	-
	-	49,384,832.58	49,384,832.58
	-	6,617,245.62	6,617,245.62

2

1

[2008]43

[2022]11

	2021 1-9	2020	2019	2018
	-1.30	-1.95	-2.06	-0.74
	8,184.57	5,096.14	4,326.27	4,691.53
	52.49	-	-	-
	1.15	207.16	2.94	0.53
	-64.05	-685.67	-17.17	-20.57
	8,172.86	4,615.68	4,309.98	4,670.76
" - "	-	-	-	-
	71.28	52.96	-	-
	8,101.59	4,562.72	4,309.98	4,670.76
	5,796.38	-1,148.90	-1,936.64	-10,322.29
	-2,305.21	-5,711.62	-6,246.63	-14,993.05

--	--	--	--

	2021 9 30 /2021 1-9	2020 12 31 /2020	2019 12 31 /2019	2018 12 31 /2018
	2.23	4.09	4.26	3.95
	1.16	2.79	2.52	2.12
	48.25%	36.41%	24.19%	25.07%
	49.67%	38.12%	24.19%	25.07%
	3.78	4.17	2.51	1.22
	0.27	0.65	0.50	0.17
	5,532.71	-602.35	-594.74	-9,023.10
	5,796.38	-1,148.90	-1,936.64	-10,322.29
	-2,305.21	-5,711.62	-6,246.63	-14,993.05
	34.65%	28.19%	29.58%	152.84%
/	-0.80	3.26	-0.28	-1.80

2

3

4

2014

375

2020

SEMI

SEMI

2020

187.2

39%

1

148.32%

2

33.00% 31.99% 34.12% 45.55%

3

152.84% 29.58% 28.19% 34.65%

1

11.28% 2020
39%

187.2

PECVD

ACHM Lok

PECVD ALD SACVD

2

2018 2020

1

	2021 1-9		2020		2019		2018	
	36,399.05	97.35%	42,876.27	98.42%	24,772.45	98.60%	6,629.86	93.85%
	990.52	2.65%	686.50	1.58%	352.70	1.40%	434.55	6.15%
	37,389.57	100%	43,562.77	100%	25,125.15	100%	7,064.40	100%

2

	2021 1-9		2020		2019		2018	
PECVD	32,283.16	88.69%	41,824.53	97.55%	24,772.45	100%	5,170.28	77.98%
PF-300T	20,692.42	56.85%	32,117.87	74.91%	14,873.60	60.04%	4,189.28	63.18%
PF-200T	11,590.74	31.84%	9,706.66	22.64%	9,898.85	39.96%	981.00	14.80%
ALD	0.00	0.00%	184.48	0.43%	0.00	0.00%	1,459.58	22.02%
SACVD	4,115.89	11.31%	867.26	2.02%	0.00	0.00%	0.00	0.00%
	36,399.05	100%	42,876.27	100%	24,772.45	100%	6,629.86	100%

PECVD ALD SACVD

PECVD

PECVD

3

PECVD						
12	PECVD	PF-300T	8	PECVD	PF-200T	PF-300T
	28nm		FLASH	DRAM		PF-200T
	90nm			3D TSV		
		1	TM		PM	PM
1-3	PM					PF-300T
PF-200T						
		2021	2020	2019	2018	
		1-9				

2021	1-9	PF-300T	2020	20.45%	2021	1-9
		Lok	PF-300T	ex		
2019		PF-200T	2018	34.54%		
2018		1 PF-200T				PF-200T
		2021	1-9	,		
		2020	14.27%			PF-200T
		PECVD				
	1					
	2					
	3					
	4			2019		
			DRAM		2020	
	4					

	2021 1-9		2020		2019		2018	
	14,684.94	40.34%	18,904.97	44.09%	10,810.00	43.64%	981.00	14.80%
	8,466.92	23.26%	12,611.71	29.41%	9,761.87	39.41%	1,459.58	22.02%
	7,216.18	19.83%	8,218.48	19.17%	1,373.15	5.54%	1,494.84	22.55%
	6,031.00	16.57%	3,141.11	7.33%	0.00	0.00%	0.00	0.00%
	0.00	0.00%	0.00	0.00%	1,500.00	6.06%	0.00	0.00%
	0.00	0.00%	0.00	0.00%	1,327.43	5.36%	2,694.44	40.64%
	36,399.05	100%	42,876.27	100%	24,772.45	100%	6,629.86	100%

5

	2021 1-9		2020		2019		2018	
	36,399.05	100%	41,429.27	96.63%	19,015.30	76.76%	6,629.86	100%
	0.00	0.00%	1,447.00	3.37%	5,757.15	23.24%	0.00	0.00%
	36,399.05	100%	42,876.27	100%	24,772.45	100%	6,629.86	100%

2020 5,757.15 1,447.00 2017 2019
23.24% 3.37%

6

	2021 1-9		2020		2019		2018	
	5,294.30	14.55%	1,444.83	3.37%	0.00	0.00%	0.00	0.00%
	5,195.10	14.27%	740.00	1.73%	0.00	0.00%	0.00	0.00%
	25,909.65	71.18%	13,693.74	31.94%	3,428.00	13.84%	4,154.02	62.66%
	/	/	26,997.70	62.97%	21,344.45	86.16%	2,475.84	37.34%
	36,399.05	100%	42,876.27	100%	24,772.45	100%	6,629.86	100%

		2020	2019	2018
		18.15%	19.33%	3.67%
		24.89%	21.82%	24.73%
		21.90%	21.39%	31.14%
		35.06%	37.47%	40.46%
		100%	100%	100%
		2.59%	4.83%	8.04%
		16.40%	26.61%	14.87%
		45.45%	13.46%	26.18%
		35.57%	55.10%	50.91%
		100%	100%	100%
		13.79%	13.02%	6.90%

		2020	2019	2018
		21.52%	26.38%	26.06%
		27.03%	36.92%	21.47%
		37.66%	23.67%	45.57%
		100%	100%	100%
		7.08%	0.34%	0.71%
		8.55%	16.36%	35.76%
		23.13%	31.02%	0.59%
		61.24%	52.27%	62.94%
		100%	100%	100%
		10.40%	9.38%	4.83%
		17.84%	22.79%	25.35%
		29.38%	25.70%	19.84%
		42.38%	42.13%	49.97%
		100%	100%	100%

	2021 1-9		2020		2019		2018	
	19,818.68	97.77%	28,249.02	98.34%	16,846.58	98.39%	4,442.10	92.03%
	452.32	2.23%	476.45	1.66%	275.81	1.61%	384.94	7.97%
	20,271.00	100%	28,725.47	100.00%	17,122.39	100%	4,827.04	100%

2

	2021 1-9		2020		2019		2018	
PECVD	18,301.32	92.34%	26,979.73	95.51%	16,846.58	100.00%	3,658.11	82.35%
PF-300T	11,482.17	57.94%	20,789.74	73.59%	10,029.46	59.53%	2,797.75	62.98%
PF-200T	6,819.15	34.41%	6,189.99	21.91%	6,817.13	40.47%	860.35	19.37%
ALD	0.00	0.00%	23.83	0.08%	0.00	0.00%	783.99	17.65%
SACVD	1,517.36	7.66%	1,245.46	4.41%	0.00	0.00%	0.00	0.00%
	19,818.68	100.00%	28,249.02	100.00%	16,846.58	100.00%	4,442.10	100.00%

PECVD

PECVD

3

	2021 1-9		2020		2019		2018	
	18,723.81	94.48%	25,531.29	90.38%	15,290.75	90.76%	3,939.76	88.69%
	232.32	1.17%	603.01	2.13%	321.78	1.91%	160.60	3.62%
	862.55	4.35%	2,114.72	7.49%	1,234.06	7.33%	341.73	7.69%
	19,818.68	100%	28,249.02	100%	16,846.58	100%	4,442.10	100%

88.69% 90.76% 90.38% 94.48% 2018
2020

" " " "

90%

1

	2021 1-9		2020		2019		2018	
PECVD	13,981.84	84.33%	14,844.80	101.49%	7,925.87	100.00%	1,512.17	69.12%
PF-300T	9,210.26	55.55%	11,328.13	77.45%	4,844.15	61.12%	1,391.53	63.61%
PF-200T	4,771.58	28.78%	3,516.67	24.04%	3,081.72	38.88%	120.65	5.51%
ALD	0.00	0.00%	160.66	1.10%	0.00	0.00%	675.59	30.88%
SACVD	2,598.52	15.67%	-378.21	-2.59%	0.00	0.00%	0.00	0.00%
	16,580.36	100.00%	14,627.25	100.00%	7,925.87	100.00%	2,187.76	100.00%

2,187.76 7,925.87

14,627.25 16,580.36 2019 262.28% 2020
84.55%

PECVD

PECVD 69.12% 100% 101.49% 84.33%

2

1

	2021 1-9		2020		2019		2018	
PECVD	43.31%	88.69%	35.49%	97.55%	31.99%	100.00%	29.25%	77.98%
PF-300T	44.51%	56.85%	35.27%	74.91%	32.57%	60.04%	33.22%	63.18%
PF-200T	41.17%	31.84%	36.23%	22.64%	31.13%	39.96%	12.30%	14.80%
ALD	0.00%	0.00%	87.09%	0.43%	0.00%	0.00%	46.29%	22.02%
SACVD	63.13%	11.31%	-43.61%	2.02%	0.00%	0.00%	0.00%	0.00%
	45.55%	100.00%	34.12%	100.00%	31.99%	100.00%	33.00%	100.00%

2021 1-9

PECVD

PECVD

		2021	1-9	2020	2019	2018
PF-300T						
	TM+PM /	449.84		373.46	362.77	349.11
		20.45%		2.95%	3.91%	
	TM+PM /	249.61		241.74	244.62	233.15
		3.26%		-1.18%	4.92%	
		44.51%		35.27%	32.57%	33.22%
		10.99%		1.93%	2.52%	
		-1.75%		0.77%	-3.16%	
		9.24%		2.70%	-0.64%	
PF-200T						
	TM+PM /	297.20		346.67	329.96	245.25
		-14.27%		5.06%	34.54%	
	TM+PM /	174.85		221.07	227.24	215.09
		-20.91%		-2.71%	5.65%	
		41.17%		36.23%	31.13%	12.30%
		-10.61%		3.32%	22.52%	
		15.55%		1.78%	-3.68%	
		4.94%		5.10%	18.84%	
	PF-300T	-3.34%		0.96%	-1.44%	-20.92%

1 = / × /

2 = / × /

3 = -

2019 PF-300T 2018

2020	PF-300T	2019	2.70%	
1.93%		0.77%	2020	PF-300T
2019	2.95%	2020	PF-300T	
ACHM		2020		
2021 1-9	PF-300T	2020	9.24%	
2021 1-9		PF-300T		,
				,
2019	PF-200T	2018	18.84%	
2018	PF-200T			
PF-200T		2019	PF-200T	
2020	PF-200T	2019	5.10%	
3.32%		1.78%	2020	PF-200T
2019	5.06%	2020	PF-200T	ACHM
	2020			
2021 1-9	PF-200T	2020	4.94%	
-10.61%		15.55%	2021 1-9	PF-200T
	2018		PF-300T	PF-200T
2018	PF-200T		PF-300T	
2018	PF-200T			
ALD				
2018	2020	ALD	46.23%	87.09%

	2021	1-9	2020	2019	2018
		42.68%	37.67%	34.93%	35.50%
		39.59%	41.95%	46.21%	46.27%
			42.65%	44.67%	43.80%
			38.17%	31.27%	25.27%
		41.13%	40.11%	39.27%	37.71%
		45.55%	34.12%	31.99%	33.00%

2018-2020

2021 1-9

PECVD

PECVD

AMAT

ASMI

Lam

PECVD

A

PECVD

2018-2020

2018-2020

2021 1-9

	2021		2020		2019		2018	
	1-9							
	5,293.91	14.16%	6,635.41	15.23%	4,697.65	18.70%	4,025.75	56.99%
	2,347.86	6.28%	2,793.24	6.41%	2,144.21	8.53%	2,250.47	31.86%
	12,955.63	34.65%	12,278.18	28.19%	7,431.87	29.58%	10,797.31	152.84%

	2021 1-9		2020		2019		2018	
	143.57	2.71%	276.28	4.16%	116.88	2.49%	133.84	3.32%
	113.08	2.14%	217.54	3.28%	203.09	4.32%	161.23	4.00%
	-	0.00%	-	0.00%	106.18	2.26%	26.86	0.67%
	52.12	0.98%	51.95	0.78%	42.89	0.91%	48.33	1.20%
	21.85	0.41%	33.00	0.50%	114.49	2.44%	110.16	2.74%
	18.63	0.35%	22.26	0.34%	23.15	0.49%	22.51	0.56%
	30.25	0.57%	17.61	0.27%	35.81	0.76%	1,054.95	26.21%
	14.27	0.27%	3.20	0.05%	4.59	0.10%	5.86	0.15%
	5,293.91	100%	6,635.41	100%	4,697.65	100%	4,025.75	100%

2021 1-9	2,761.96	1,819.95	1,047.16	3,534.75
2020	1,250.49	2,143.81	632.35	2,761.96
2019	384.47	1,238.62	372.61	1,250.49
2018	517.82	331.49	464.84	384.47

5,533.87

2,516.96

	2016 2018 3%-5% 2019 2020
	2%
	3% 5%

2020

2019

242.27%

2020

2018-2020

2020

2021 1-9

2019
2020

2018
2019

41.86

25.96%

2018 5

2018
2018 8

2019

2018

2018

1,014.90

"

" "

"

3

	2021	1-9	2020	2019	2018
		10.14%	10.41%	10.12%	13.21%
		9.26%	11.34%	9.67%	8.23%
			10.49%	11.20%	10.91%
			9.51%	12.75%	40.61%
		9.70%	10.44%	10.94%	18.24%
		14.16%	15.23%	18.70%	56.99%

2018

2018

2

1

2019

2018

4.72%

2020

2019

649.04

30.27%

445.17

2





	2021 1-9		2020		2019		2018	
	4,645.45	35.86%	3,806.90	31.01%	2,651.82	35.68%	4,981.58	46.14%
	3,673.06	28.35%	3,694.03	30.09%	2,701.16	36.35%	2,310.11	21.40%
	3,463.12	26.73%	3,221.07	26.23%	662.35	8.91%	1,657.75	15.35%
	626.40	4.83%	909.87	7.41%	862.53	11.61%	1,022.15	9.47%
	329.91	2.55%	243.25	1.98%	282.69	3.80%	313.76	2.91%
	32.71	0.25%	207.76	1.69%	68.28	0.92%	67.37	0.62%
	152.87	1.18%	165.17	1.35%	168.45	2.27%	177.56	1.64%
	32.11	0.25%	30.14	0.25%	34.60	0.47%	267.03	2.47%
	12,955.63	100%	12,278.18	100.00%	7,431.87	100.00%	10,797.31	100.00%

2018

2018

PECVD

CIP

CIP

PECVD

2018-2020

ICRD
ICRD

2018 2020
2021 1-9

2018 2020

2021 1-9

2019 2018 15.62% 2020

2019 5.49%

2019

2018

2019

"

" "

"

3

	2021 1-9	2020	2019	2018
3D NAND PECVD	721.01	3,518.41	3,674.64	4,520.12
28nm	4,177.78	2,708.24	-	-
28nm-14nm	2,484.90	1,777.83	1,742.56	1,745.99
PF-200T/PF-300&PF-300T	1,758.05	1,444.15	1,064.19	2,752.35

	2021	1-9	2020	2019	2018
ALD		1,196.83	888.52	770.99	1,476.79
40nm		19.36	646.74	97.21	300.16
ALDHTM SiO ₂		851.15	613.16	-	-
		1,110.22	353.00	64.98	1.90
		119.62	188.59		
TF-Lite		78.71	125.26	17.29	-
28nm Thermal ALD AlO _x		95.23	14.29	-	-
12 HDPCVD		342.78			
		12,955.63	12,278.18	7,431.87	10,797.31

2020

2019
2018

5

6

		SAP

4

	2021 1-9	2020	2019	2018
--	-----------------	-------------	-------------	-------------

	2021 1-9	2020	2019	2018	
A	4,693.24	1,224.58	-	-	
B PECVD	1,960.41	1,488.71	-	-	
A ALD	432.53	453.79	-	-	
02	-	-	2,363.24	2,870.54	
02	218.12	293.45	300.69	300.89	
	111.47	214.80	427.60	239.80	
	50.03	214.29	289.90	478.09	
	116.78	155.71	155.71	155.71	
2020	-	240.00	-	-	
2019	-	41.00	-	-	
2019	-	-	170.00	-	
2020	-	60.00	-	-	
2019	-	-	100.00	-	
2019	-	-	60.00	-	
2018	-	-	-	60.00	
" "	8.32	29.18	-	-	
	43.27	57.60	56.56	50.20	
	-	-	3.38	122.06	
	21.69	30.16	109.38	92.11	
	4.42	5.91	10.10	10.56	

	2021 1-9	2020	2019	2018	
" "	-	-	9.56	69.19	
" "	2.85	4.23	3.93	0.12	
	0.35	52.91	7.78	7.78	
	-	-	164.40	17.51	
	-	24.50	-	-	
	-	50.00	-	-	
	39.38	96.49	-	-	
	-	30.00	30.00	-	
	-	-	10.00	-	
	285.10	211.85	-	-	
	-	-	-	22.00	
	1.17	23.70	38.20	45.02	
	-	64.68	-	17.00	
	45.00	-	-	-	
B	23.17				
	10.00				
R&D	-	-	-	106.00	
	7.27	28.59	15.84	26.94	
	8,074.57	5,096.14	4,326.27	4,691.53	

	2021 1-9	2020	2019	2018
	8,074.57	5,096.14	4,326.27	4,691.53
	37,389.57	43,562.77	25,125.15	7,064.40
	21.60%	11.70%	17.22%	66.41%

2018

2020

1

	2021 1-9	2020	2019	2018			
	-	-	-	100,000	2014 1		
	3,080	9,900	13,300	15,000			1.11
	-	-	-	40,000	2015 7		
	119,200	1,610,640	9,286,500	-	2019 12		19.00
	122,280	1,620,540	9,299,800	155,000			

2010

3 5

2014

2017

2018 2019
68.92 35.70 2019

11 6

	2021 1-9	2020	2019	2018
	21.85	33.00	114.49	110.16
	17.10	452.16	6.99	13.86
	32.71	207.76	68.28	67.37
	1.10	-	8.49	1.57
	72.76	692.92	198.25	192.96

2019 929.98 2018 2020
2019 2018 2020
2019 928.65
19

2

2020 5 31

2020 6 2020

2019

2020 12 31

2021 3630

	/	
2014	10.10	2015 3295
2015	11.11	2015 3695

		/		
2016		18.50	2017	3411
2017		18.50	2017	3411
2018		19.00	2018	3695
2019		19.00	2019	3500
2020	1-5	19.00	2019	3500
2020	6-12	24.50	2021	3630
2021	1-9	24.50	2021	3630

1

2018

2019 1 1

288.26 14.90 520.96

177.19

2

2019 1 1

0.00 96.46 -94.56 -159.28

3

	2021 1-9	2020	2019	2018
	111.15	207.25	3.94	0.53

	2021 1-9	2020	2019	2018
	-	1.56	3.06	-

2020

2020 5

2019 12

623.3158

1

1

2

"

"

3

2019 2020

2

3

2021 40

2024 80

2024

4

"

" "

" "

"

"

"

2021 1-9

/%

	2021 1-9	2020 1-9		
	37,389.57	16,329.89	21,059.67	128.96%
	5,627.12	-5,830.60	11,457.72	-

	2021 1-9	2020 1-9		
	5,738.27	-5,629.12	11,367.39	-
	5,704.87	-5,629.12	11,333.99	-
	5,796.38	-5,629.12	11,425.49	-
	-2,305.21	-6,887.65	4,582.44	-

1

2 2020 1-9

2021 1-9

21,059.67

128.96%

11,425.49

4,582.44

1

	2021 9 30	2020 12 31	2019 12 31	2018 12 31
	203,685.11	160,904.30	85,655.87	69,425.69
	86.85%	88.70%	79.75%	74.94%
	30,844.78	20,502.61	21,755.82	23,218.87
	13.15%	11.30%	20.25%	25.06%
	234,529.89	181,406.91	107,411.69	92,644.56
	100%	100%	100%	100%

2

	2021 9 30		2020 12 31		2019 12 31		2018 12 31	
	80,530.50	39.54%	100,399.75	62.40%	36,216.88	42.28%	27,545.21	39.68%
	350.00	0.17%	-	0.00%	40.00	0.05%	-	0.00%
	12,227.12	6.00%	7,189.17	4.47%	13,138.86	15.34%	6,271.99	9.03%
	4,504.38	2.21%	368.10	0.23%	207.80	0.24%	278.27	0.40%
	424.78	0.21%	300.44	0.19%	306.93	0.36%	1,499.40	2.16%
	97,838.83	48.03%	51,208.04	31.83%	34,997.69	40.86%	32,232.77	46.43%
	810.53	0.40%	264.82	0.16%	-	0.00%	-	0.00%
	182.36	0.09%	53.56	0.03%	-	0.00%	-	0.00%
	6,816.60	3.35%	1,120.42	0.70%	747.72	0.87%	1,598.04	2.30%
	203,685.11	100.00%	160,904.30	100%	85,655.87	100%	69,425.69	100%

95.14% 98.48% 98.69% 93.57%

1

	2021 9 30	2020 12 31	2019 12 31	2018 12 31
	80,530.50	100,399.75	36,216.88	27,545.21
	0.45	0.12	0.18	0.15
	76,631.38	94,977.90	34,685.21	26,240.51
	3,898.67	5,421.73	1,531.49	1,304.55

39.68% 42.28% 62.40% 39.54%

2019 2018 8,671.67 31.48%
2019 12 2019 13,750.00

2020 2019 64,182.87 177.22%
2020 2020 30,891.27
64,036.36 31,250.00
2020 2019 12 31,250.00

2021 9 2020 19,869.25

10,427.23

	2021 9 30	2020 12 31	2019 12 31	2018 12 31
	-	2,399.00	-	-
	3,626.00	2,793.63	1,092.79	1,154.55
	48.90	229.10	438.70	150.00
	223.77	-	-	-
	3,898.67	5,421.73	1,531.49	1,304.55

	2021 9 30	2020 12 31	2019 12 31	2018 12 31
	-	-	140.02	-
	3,898.67	5,421.73	1,671.51	1,304.55

2

	2021 9 30	2020 12 31	2019 12 31	2018 12 31
	12,356.92	7,406.55	13,476.81	6,540.84
	129.80	217.38	337.95	268.85
	12,227.12	7,189.17	13,138.86	6,271.99
	1.05%	2.93%	2.51%	4.11%

	2021 9 30	2020 12 31	2019 12 31	2018 12 31
	12,356.92	7,406.55	13,476.81	6,540.84
	66.84%	-45.04%	106.04%	-
	37,389.57	43,562.77	25,125.15	7,064.40
	-	73.38%	255.66%	-
	-	17.00%	53.64%	92.59%

2021 1-9

2018-2020

2020

2018

1-1-260

2018

4

5,046.31

2019

2020

	2021 9 30		2020 12 31		2019 12 31		2018 12 31	
6	12,226.12	98.94%	6,536.83	88.26%	12,232.00	90.76%	5,232.91	80.00%
7-12	120.82	0.98%	9.98	0.13%	26.13	0.19%	189.79	2.90%
1-2	9.98	0.08%	408.71	5.52%	1,002.29	7.44%	439.60	6.72%
2-3	-	-	451.03	6.09%	9.39	0.07%	624.76	9.55%
3-4	-	-	-	-	207.00	1.54%	53.78	0.82%
	12,356.92	100.00%	7,406.55	100.00%	13,476.81	100.00%	6,540.84	100.00%

80%

2

	2021		2020		2019		2018	
	9	30	12	31	12	31	12	31
6	12,226.12	122.26	6,536.83	65.37	12,232.00	122.32	5,232.91	52.33
7-12	120.82	6.04	9.98	0.50	26.13	1.31	189.79	9.49
1-2	9.98							

	1-2	14.84	10.00	10.00	15.00	15.00
	2-3	60.78	30.00	20.00	20.00	20.00
	3-4	96.49	50.00	25.00	30.00	30.00
	4-5	100.00	80.00	30.00	50.00	50.00
	5	100.00	100.00	100.00	100.00	

		1,569.72	11.65%
		1,158.66	8.60%
		11,820.32	87.72%
2018 12 31		3,342.29	51.10%
		1,734.01	26.51%
		317.89	4.86%
		300.31	4.59%
		252.72	3.86%
		5,947.22	90.92%

a.

b.

c.

d.

e.

ICRD

GLOBAL FUNDAMENTAL LIMITED

	2021 9 30	2020 12 31	2019 12 31	2018 12 31
	12,356.92	7,406.55	13,476.81	6,540.84
	11,209.07	6,954.40	13,422.71	6,540.84
	90.71%	93.90%	99.60%	100.00%

	2021		2020		2019		2018	
	9	30	12	31	12	31	12	31
	18,917.83	19.10%	8,916.73	17.02%	5,919.63	16.54%	10,260.48	31.04%
	19,012.47	19.20%	5,204.95	9.94%	6,274.73	17.54%	2,525.28	7.64%
	1,599.90	1.62%	1,414.76	2.70%	-	0.00%	3,135.06	9.49%
	59,321.12	59.90%	36,746.35	70.15%	23,503.18	65.68%	17,016.48	51.48%
	138.36	0.14%	85.61	0.16%	74.85	0.21%	101.38	0.31%
	42.17	0.04%	12.76	0.02%	10.61	0.03%	13.42	0.04%
	99,031.84	100.00%	52,381.17	100.00%	35,782.99	100.00%	33,052.11	100.00%
	-1,193.01	-1.20%	1,173.13	2.24%	785.31	2.19%	819.34	2.48%
	97,838.83	98.80%	51,208.04	97.76%	34,997.69	97.81%	32,232.77	97.52%

99.66% 99.76% 99.81%

99.82%

a

2019 2018 4,340.85 42.31%
 2018 demo 2018

demo

2018

2018

2020 2021 9

b

3 0 1 1

5,660.35

6,274.73 6,619.72 20,612.37

c

	2021	2020	2019	2018
	9 30	12 31	12 31	12 31
	1,181.67	1,164.17		

2018	579.32	284.53	44.51	819.34
2019	819.34	14.90	48.93	785.31
2020	785.31	521.14	142.28	1,164.17
2021 1-9	1,164.17	169.67	152.17	1,181.67

100%

b

2020 TFLITE 8.96 2021
 9 1.65

!

Demo

Demo

Demo

4

	2021 9 30	2020 12 31	2019 12 31	2018 12 31
	404.69	301.86	314.16	980.87
	-	-	-	464.28
	38.53	36.24	45.94	26.94
	-	-	-	53.12
	443.23	338.10	360.10	1,525.21
	18.45	37.65	53.17	25.81
	424.78	300.44	306.93	1,499.40

2019

2018

2019

	2021 9 30		2020 12 31		2019 12 31		2018 12 31	
					27.29	27.29		
	443.23	18.45	338.10	37.65	332.81	25.88	1,060.93	25.81
6	233.25	2.33	198.70	1.99	207.46	2.07	953.46	9.53
7-12	157.17	7.86	13.28	0.66	6.90	0.34	0.53	0.03

	2021		2020		2019		2018	
	9	30	12	31	12	31	12	31
1-2	46.12	6.92	14.44	2.17	12.05	1.81	105.13	15.77
2-3	6.67	1.33	6.68					

	2021		2020		2019		2018	
	9	30	12	31	12	31	12	31
3	-	0.00%	-	0.00%	-	0.00%	-	0.00%

	2021		2020		2019		2018	
	9	30	12	31	12	31	12	31
	-	0.00%	-	0.00%	-	0.00%	6.00	0.03%
	15,839.98	51.35%	16,469.53	80.33%	17,783.09	81.74%	19,101.81	82.27%
	10,039.34	32.55%	-	0.00%	-	0.00%	-	0.00%
	167.88	0.54%	-	0.00%	-	0.00%	-	0.00%
	3,676.34	11.92%	3,819.84	18.63%	3,972.73	18.26%	4,084.66	17.59%
	140.30	0.45%	-	0.00%	-	0.00%	-	0.00%
	980.94	3.18%	213.24	1.04%	-	0.00%	26.40	0.11%
	30,844.78	100.00%	20,502.61	100.00%	21,755.82	100.00%	23,218.87	100.00%

99.86% 100% 98.96% 95.82%

2021 9 2020 10,342.18
10,039.34

1

	2021		2020		2019		2018	
	9	30	12	31	12	31	12	31
	10,922.33	68.95%	11,409.31	69.28%	12,082.34	67.94%	12,751.62	66.76%
	294.33	1.86%	210.21	1.28%	158.44	0.89%	195.67	1.02%
	4,570.79	28.86%	4,838.89	29.38%	5,519.09	31.04%	6,119.24	32.03%
	52.53	0.33%	11.12	0.07%	23.22	0.13%	35.28	0.18%

	2021		2020		2019		2018	
	9	30	12	31	12	31	12	31
	15,839.98	100.00%	16,469.53	100.00%	17,783.09	100.00%	19,101.81	100.00%

98.79% 98.98% 98.66% 97.81%

a

	2021	2020	2019	2018
	9	12	12	12
	30	31	31	31
	14,107.99	14,090.19	14,090.19	14,090.19
	789.93	654.40	535.22	466.66
	7,400.03	7,158.61	7,200.19	7,083.50
	142.03	90.80	106.32	106.32
	22,439.98	21,993.99	21,931.91	21,746.67
	3,185.65	2,680.88	2,007.85	1,338.57
	495.60	444.18	376.78	270.99
	2,829.25	2,319.71	1,681.10	964.26
	89.50	79.68	83.10	71.04
	6,600.00	5,524.46	4,148.83	2,644.85
	10,922.33	11,409.31	12,082.34	12,751.62
	294.33	210.21	158.44	195.67
	4,570.79	4,838.89	5,519.09	6,119.24
	52.53	11.12	23.22	35.28
	15,839.98	16,469.53	17,783.09	19,101.81

2021 1-9

10,039.34

b

				%
			20	5
			3-7	0-5
			3-10	5
			3	0
			5	5
			20	5
			5-10	5
			5	5
			5	5
			10	5
			5-10	5
			3-5	5
			5	5
			4-5	5
			10	3
			3	3

				%
			5	3
			5	3
			4	3
			20	5
			3-5	5

5-10

	2021 9 30		2020 12 31		2019 12 31		2018 12 31	
	3,402.84	62.64%	3,402.84	63.15%	3,402.84	64.42%	3,402.84	66.16%
	1,548.94	28.52%	1,548.94	28.75%	1,548.94	29.33%	1,410.00	27.42%
	480.19	8.84%	436.65	8.10%	330.19	6.25%	330.19	6.42%
	5,431.97	100.00%	5,388.43	100.00%	5,281.97	100.00%	5,143.03	100.00%

93.58% 93.75% 91.90% 91.16%

	2021 9 30		2020 12 31		2019 12 31		2018 12 31	
	460.74	26.24%	409.52	26.11%	341.23	26.06%	272.94	25.79%
	1,139.42	64.90%	1,046.58	66.72%	891.69	68.11%	742.58	70.16%
	155.47	8.86%	112.49	7.17%	76.32	5.83%	42.84	4.05%
	1,755.63	100.00%	1,568.59	100.00%	1,309.24	100.00%	1,058.37	100.00%

	2021 9 30	2020 12 31	2019 12 31	2018 12 31
	91,254.93	39,354.60	20,111.21	17,580.20
	25,247.45	29,802.43	5,873.52	5,649.02
	116,502.38	69,157.03	25,984.73	23,229.21
	78.33%	56.91%	77.40%	75.68%
	21.67%	43.09%	22.60%	24.32%
	100.00%	100.00%	100.00%	100.00%

75.68% 77.40% 56.91% 78.33%

2

0.10%0.10%

	2021 9 30	2020 12 31	2019 12 31	2018 12 31
	-	-	-	3,015.67
	12,086.67	9,158.62	3,622.92	2,917.57
	26,440.52	12,242.51	8,239.36	6,093.08
	-	-	5,600.21	4,684.20
	44,514.16	13,425.71	-	-
	1,873.61	2,242.46	1,108.20	671.68
	487.45	505.88	219.88	180.13
	4.78	34.09	1,320.64	17.88
	0.00%	0.00%	0.00%	17.15%
	13.24%	23.27%	18.01%	16.60%
	28.97%	31.11%	40.97%	34.66%
	0.00%	0.00%	27.85%	26.64%
	48.78%	34.11%	0.00%	0.00%
	2.05%	5.70%	5.51%	3.82%
	0.53%	1.29%	1.09%	1.02%
	0.01%	0.09%	6.57%	0.10%
	61.04	-	-	-
	0.07%	0.00%	0.00%	0.00%

	2019		2018	69.38%
	2018	19,110.23	2019	20,194.48
2019		2018		

13,425.71	44,514.16				
			4,684.20	5,600.21	0.00
0.00	2020	1	1		
	2020		0	2020	2021 9
	13,425.71		44,514.16		
5					
			671.68	1,108.20	2,242.46
1,873.61					
2021 9			2020		2020
6					

	2021 9 30	2020 12 31	2019 12 31	2018 12 31
	252.44	-	-	-
	173.62	-	-	-
	33.01	482.25	194.39	159.93
	11.79	11.82	11.74	11.79
	5.21	5.21	5.21	5.21
	11.39	6.59	8.54	3.19
	487.45	505.88	219.88	180.13

	7						
	4.78	2019		17.88	1,320.64	34.09	
						2019	
					1,258.00	2020	

	8						
	2020	2021	9			1,745.34	
	5,786.69					2020	
	2021	9				13%	

3

	2021 9 30		2020 12 31		2019 12 31		2018 12 31	
	-	0.00%	-	0.00%	-	0.00%	53.82	22.74 reWhB
	89.50	0.35%						

1

2018-2020

2

	2021 9 30	2020 12 31	2019 12 31	2018 12 31
	21,623.11	27,040.47	4,623.03	5,262.44
	-	-	-	-33.00
	21,623.11	27,040.47	4,623.03	5,229.44

	2021 9 30	2020 12 31	2019 12 31	2018 12 31	
A	6,041.18	10,734.42	-	-	
	4,503.04	4,788.15	-	-	
PECVD B	3,413.66	4,906.21	-	-	
PECVD B	450.00	450.00	-	-	
ALD A	3,373.05	2,135.08	-	-	
02	1,956.64	2,174.77	2,468.22	2,768.90	
	1,055.11	1,171.88	1,327.59	1,483.29	
	403.89	447.16	504.76	561.32	
B	192.83	-	-	-	
	90.56	112.25	141.51	204.28	

	2021	2020	2019	2018	
	9 30	12 31	12 31	12 31	
" "	62.50	70.82	-	-	
	31.62	36.03	41.94	52.04	
	20.00	-	-	-	
	18.53	-	-	-	

"

"

		2021 9 30	2020 12 31	2019 12 31	2018 12 31
		32.16%	40.39%	39.25%	65.58%
		49.67%	38.12%	24.19%	25.07%

"

"

"

"

1

1

	2021 1-9	2020	2019	2018
	71,462.90	64,036.36	21,876.12	11,450.60
	37,389.57	43,562.77	25,125.15	7,064.40
/	191.13%	147.00%	87.07%	162.09%

85%

2

-12,801.52

-2,175.61

30,891.27

-7,597.27

2018-2020

2018

2019

2020

2021

1-9

	2021 1-9	2020	2019	2018
	-7,597.27	30,891.27	-2,175.61	-12,801.52
	5,704.87	-1,169.99	-1,936.64	-10,322.29
	-13,302.14	32,061.26	-238.96	-2,479.23
	17.91	426.41	111.36	288.26
	1,102.12	1,454.98	1,506.53	1,480.66
	16.53			
	187.04	259.35	250.87	242.19
" "	1.30	0.48	-	0.74
" "	-	1.48	2.06	-
" "	-36.03	119.38	35.07	107.55
" "	-140.22			
" "	-46,802.84	-16,740.45	-2,779.82	-10,590.24
" "	-7,478.68	2,802.39	-5,024.08	2,232.78
" "	39,757.97	43,044.33	5,460.78	3,565.87
	72.76	692.91	198.25	192.96
	-13,302.14	32,061.26	-238.96	-2,479.23

2020

32,061.26

2020

2

" " "

"

-270.97 -1,437.47

-584.23 -10,427.23

2021 1-9

3

" " "

"

-4,528.72

11,917.78 30,244.99 -359.56

4

2021 1-9

/%

	2021 1-9	2020 1-9		
	71,462.90	22,415.73	49,047.17	218.81%
	68,668.58	28,776.28	39,892.30	138.63%
	-7,597.27	-11,078.32	3,481.05	
	-10,427.23	-358.41	-10,068.82	
	-359.56	30,194.99	-30,554.55	

1

2 2020 1-9

2021 1-9

2021 1-9

2021 1-9

1

556.57 1,437.47 631.02

10,427.34

2

1

2

" "

" "

43,266.17

"

" " " " 2 "

" 1 "

3

4

1

	2021 1-9	2020	2019	2018
	3.78	4.17	2.51	1.22
	0.27	0.65	0.50	0.17

2021 1-9

2020

2

2018-2020

		2020	2019	2018
		7.22	4.82	3.40
		4.33	3.63	5.02
		4.19	3.80	3.91
		3.85	5.37	1.40
		4.90	4.41	3.43
		4.17	2.51	1.22
		1.20	1.01	0.94

2

"

" "

" "

"

3

"

" "

" "

"

4

2

50%

80,530.50

"

"



"

" "

" "

"

"

" "

"

"

" "

" " 3 "



2021

	7,986.46	7,986.46	> 2103-210112-04-02-424612 <
	39,948.34	39,948.34	< 2103-210112-04-02-185923 >
ALD	27,094.85	27,094.85	2108-310115-04-05-492438
	25,000.00	25,000.00	
	100,029.65	100,029.65	-

2021 3 31 2021

2

"

"

1

1

2

2020

3

2

1

2

2010

3

PECVD

PECVD

ALD

1



2,600

2

2

" "

2015 4 29

[2015]0026

" "

2021

6

1

28nm-10nm PECVD
 10nm PECVD UV Cure

2

3

1		8,052.02	20.16%
1.1		8,052.02	20.16%
2		31,113.02	77.88%
2.1		4,284.32	10.72%
2.2		5,300.00	13.27%

2.3

7

PECVD

ALD

1

ALD

ALD

28nm-10nm

ALD

2

3

1		12,186.98	44.98%
1.1		6,877.10	25.38%
1.2		289.52	1.07%
1.3		2,064.80	7.62%
1.4		738.51	2.73%
1.5		2,217.05	8.18%
2		13,204.20	48.73%
2.1		3,119.20	11.51%
2.2		600.00	2.21%
2.3		9,485.00	35.01%

3	2%	507.83	1.87%
4		1,195.84	4.41%
		27,094.85	100.00%

3

36

		T+6	T+12	T+18	T+24	T+30	T+36
1							
2							
3							
4							

T 6 12

4

2021 8 17

2108-310115-04-05-492438

5

2021 9 18

ALD

[2021]78

6

ALD

13

1

PECVD

PE-ALD

SACVD

/

2

3

189

44.06%

4

2019

2016

2017

"

"

1

2

10nm

PECVD

ALD

Thermal ALD

PE ALD

SACVD

12

28nm

SACVD

3

4



5



2

3

10%

80%

40%

20%

"

"

50%

5,000

30%

4

5

2

1

$2/3$

2

40%



2019

3

2021 3 31

2021



1

36

51%

2

32

"

"

"

5

"

"



"

5%

"

"

"

5

"

"

"

"

"

"

5

"

"

"

"

"

"

5

"

"

"

"

"

"

5

"

"

"

"

"

"

5

"

"

"

5%

" " " 5 " "

" " " " " 5 "

" " " " 5 " "



	2018	2,441.00	PECVD		
	2019	12,517.91			
	2020	16,343.19			
	2021	20,721.70			
		52,023.80			
	2018	2,966.07	PECVD		2018 10 15
	2019	7,356.15			

--	--

		4,847.60			
	2021	2,920.00	PECVD		
		2,920.00			

1,000

2021					
MKS Instruments Hong Kong Limited	2021/6/7	USD	870.02		
NGK INSULATORS,LTD.	2021/2/23	JPY	60,000.00		
Rorze Corporation	2021/9/5	JPY	57,304.20		
Rorze Corporation	2021/7/13	JPY	55,508.90		
Rorze Corporation	2021/7/13	JPY	47,671.32		

2020					
Brooks Automation, Inc.	2020/10/13	USD	348.18		
XP POWER LLC	2020/3/19	USD	248.12		
MKS Instruments Hong Kong Limited	2020/10/16	USD	232.28		
Rorze Corporation	2020/6/29	JPY	23,318.13		
XP POWER LLC	2020/7/22	USD	146.49		

2019

					%	
2017.8.11		5500.00	5,614.4933	6	5.539	

1

						%	
		1					

2017.6.28

第十二节 声明

一、发行人全体董事、监事、高级管理人员声明

本公司全体董事、监事、高级管理人员承诺本招股意向书不存在虚假记载、误导性陈述或重大遗漏，并对其真实性、准确性、完整性承担个别和连带的法律责任。

全体董事签字:

 QIANG JIYU

QIANG JIYU

强继宇

强继宇

强继宇

强继宇

强继宇

强继宇

强继宇

强继宇

 CHEN CHANG

CHEN CHANG

陈畅

陈畅

陈畅

陈畅

陈畅

陈畅

陈畅

陈畅

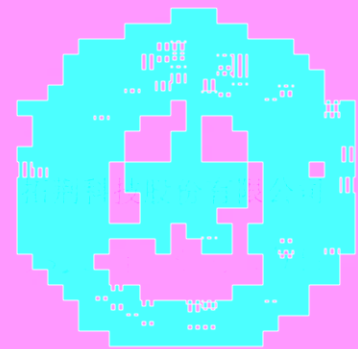

一、发行人全体董事、监事、高级管理人员声明

本公司全体董事、监事、高级管理人员承诺本招股意向书不存在虚假记载、误导性陈述或重大遗漏，并对其真实性、准确性、完整性承担个别和连带的法律责任。

全体监事签字：

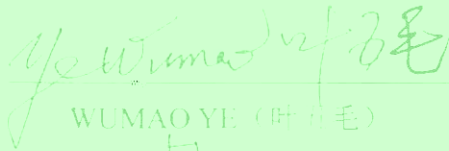
WUMAO YE (叶五毛)



郭 郢

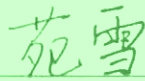

苑 雪



郭 郢



许荣伟

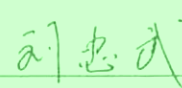

刘忠武

拓荆科技股份有限公司
2022年3月29日

一、发行人全体董事、监事、高级管理人员声明

本公司全体董事、监事、高级管理人员承诺本招股意向书不存在虚假记载、误导性陈述或重大遗漏，并对

承诺：

1、

2、

3、

4、

5、

6、

7、

8、

9、

10、

11、

12、

13、

14、

15、

16、

17、

18、

19、

20、

21、

22、

23、

24、



二、发行人主要股东声明

本公司或本人承诺在招股意向书不存在虚假记载、误导性陈述或重大遗漏，并对其



三、保荐人（主承销商）声明

本公司已对招股意向书进行了审慎的核查，认为招股意向书符合《公司法》、《证券法》、《管理办法》、《发行管理办法》、《保荐办法》、《上市公司章程指引》、《上市规则》、《自律监管指引第1号》等法律法规的要求，不存在虚假记载、误导性陈述或者重大遗漏，并对其真实性、准确性和完整性承担相应的法律责任。

 王舒	 王舒	
 王舒	 王舒	
 王舒	 王舒	
 王舒	 王舒	 

招股意向书的声明

本人已认真阅读拓荆科技股份有限公司招股意向书的全部内容，确认招股意向书不存在虚假记载、误导性陈述或者重大遗漏，并对招股意向书真实性、准确性、完整性、及时性承担相应法律责任。

保荐机构总经理：

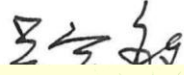

保荐机构法定代表人：



保荐机构法定代表人：



招商证券股份有限公司

2022年 月 日

联席主承销商声明

本公司已对招股意向书进行了核查，确认不存在虚假记载、误导性陈述或重大遗漏，并对其真实性、准确性、完整性承担相应的法律责任。

法定代表人：

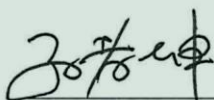

孙孝坤



发行人律师声明

本所及经办律师已阅读招股意向书，确认招股意向书与本所出具的法律意见书和律师工作报告无矛盾之处。本所及经办律师对发行人在招股意向书中引用的法律意见书和律师工作报告的内容无异议，确认招股意向书不致因上述内容而出现虚假记载、误导性陈述或重大遗漏，并对其真实性、准确性、完整性、及时性的法律责任。

书和律师
法律意见
现虚假记
承担相应

负责人：

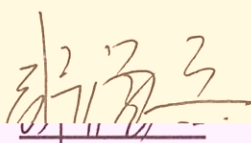

张学兵

律师事务

师：

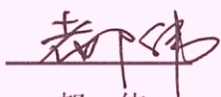

都伟



刘佳

经办律

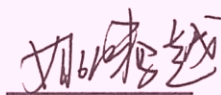

姚腾越



北京中伦律师事务所（盖章）



2022年3月27日

七、资产评估机构声明（一）

本机构及签字注册资产评估师已阅读拓荆科技股份有限公司首次公开发行股票并在科创板上市招股意向书，确认招股意向书与本机构出具的资产评估报告无矛盾之处。本机构及签字注册资产评估师对发行人在招股意向书中引用的资产评估报告的内容无异议，确认招股意向书不致因上述内容而出现虚假记载、误导性陈述或重大遗漏，并对其真实性、准确性、完整性承担相应的法律责任。

评估机构负责人：



权忠光

评估师：



资产评估师
王晨煜
24000264



资产评估师
王少岩
24200016

资产评估师

签字资产



七、资产评估机构声明(二)

本机构及签字注册资产评估师已阅读招股意向书,确认招股意向书与本机构出具的资产评估报告不存在矛盾、冲突。本机构及签字注册资产评估师对招股意向书中引用的资产评估报告内容无异议,愿意为招股意向书内容的真实性、准确性、完整性承担相应的法律责任。本机构及签字注册资产评估师与发行对象之间不存在任何关联关系,对发行对象不存在任何依赖关系,且与发行对象之间没有就任何事项提供咨询意见、建议和意见,以及其他任何可能影响资产评估报告公正、独立、客观、准确性的行为。

资产评估机构(盖章) _____
资产评估师(签字) _____
资产评估师(签字) _____

资产评估机构(盖章) _____
资产评估师(签字) _____
资产评估师(签字) _____

资产评估机构(盖章) _____
资产评估师(签字) _____
资产评估师(签字) _____



验资机构声明

本所及签字注册会计师已阅读《拓荆科技股份有限公司首次公开发行股票并在科创板上市招股意向书》（以下简称招股意向书），确认招股意向书与本所出具的《验资报告》（天健验〔2021〕120 号）的内容无矛盾之处。本所及签字注册

确认招股意向书不致因上述内容而出现虚假记载、误导性陈述或重大遗漏，并对

引用的上述内容的真实性、准确性和完整性承担相应的法律责任。

签字注册会计师：

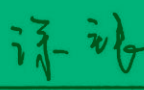
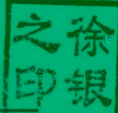
   
陈焱鑫 徐 银

天健会计师事务所负责人：

 
王国海





天健会计师事务所

Pan-China Certified Public Accountants

地址：杭州市钱江路1366号

邮编：310020

电话：(0571) 8821 6888

传真：(0571) 8821 6999

验资复核机构声明

本所及签字注册会计师已阅读《拓荆科技股份有限公司首次公开发行股票并在科创板上市招股意向书》（以下简称招股意向书），确认招股意向书与本所出具的《实收资本复核报告》（天健验（2021）116号）的内容无矛盾之处。本所及签字注册会计师对拓荆科技股份有限公司在招股意向书中引用的上述报告的内容无异议，确认招股意向书不致因上述内容而出现虚假记载、误导性陈述或重大遗漏，并对其真实性、准确性、完整性承担个别和连带的法律责任。



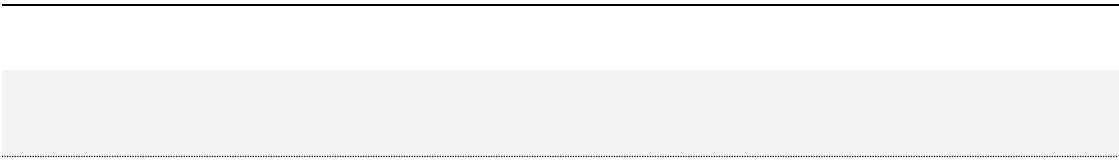

1

1	900-1 1-4		2019 0290319	9,235.07		
2	900-2 1-2		2019 0290359	9,615.08		
3	900-3		2019 0290352	13,242.99		
4	900-4		2019 0290346	5,929.75		
5	900-5		2019 0290340	12.25		
6	900-6		2019 0290330	30.25		

1
2021 12 31 100 50,202 2021 1 1

2

1			9 4 SZ10-R59	8		2021.6.1-2022.5.31
2			501 1 4 403	128.4		2021.10.9-2022.4.8
3			8 3	4331.6		2020.11.30-2023.11.29
4			1 3 3 07 A072	1		2021.9.3-2022.9.2

5			100 E1 2FA	66.1		2021.1.1-2022.12.31
6			D108-1&D208-2	55.14		2020.12.21-2022.12.20
7			9 904 2	90		2021.6.16-2022.6.15
8			75 2401	100		2021.04.08-2022.04.07
9			28 1 401	125		2021.1.5-2023.1.4
10			7-1-1802	129.53		2020.11.1-2022.10.31
11			9-2-2404	130		2020.12.26-2022.12.25
12			49 4-16-1	80.63		2021.03.05-2022.03.04
13			389 42 301	110.56		2021.06.15-2024.06.14
14			38 3 301 A	129.32		2021.06.10-2022.06.09
15			C C-909	75.19		2021.06.10-2022.06.09
16			3 1 A 5 501-10	568		2021.07.01-2024.05.30
17			5	80.47		2021.05.12-2023.05.11
18			99 2# 203	354		2021.11.15-2026.12.14
19			10 2501	132.95		2021.11.20-2022.11.19
20			40 11 402	60		2021.12.17-2022.12.17

21			2# 901	144.72		2022.1.15-2023.1.14
22			168 3 1309	108.41		2022.1.20-2023.1.19
23			9#3001	111.1		2022.2.18-2023.1.17
24			99 16# 116	84		2022.1.1-2026.12.30

4 5 6 11 17 20

1

2

392.71

3

2022 3 8 24

3

1		48881796	37			2021.3.21-2031.3.20
2	Piotech	42116687	37			2020.11.28-2030.11.27
3	ThinFilmLite	38930046	7			2020.02.21-2030.02.20

4	ThinFilmLite	38930045	37			2020.02.21-2030.02.20
5	TFLITE	38930044	7			2020.02.21-2030.02.20
6	TFLITE	38930043	37			2020.02.21-2030.02.20
7	Piotech	34370246	7			2021.01.14-2031.01.13
8	Piotech	34357464	11			2021.01.14-2031.01.13
9	Piotech	34346794	37			2019.10.14-2029.10.13
10	拓荆科技	30904119	7			2019.02.21-2029.02.20
11	拓荆科技	30904118	11			2019.02.21-2029.02.20
12	拓荆科技	30904117	37			2019.02.21-2029.02.20
13		30904116	7			2020.08.28-2030.08.27
14		30904115	11			2020.03.28-2030.03.27
15		30904114	37			2020.11.28-2030.11.27
16		30904113	7			2019.06.28-2029.06.27
17		30904112	11			2019.02.21-2029.02.20
18		30904111	37			2019.02.21-2029.02.20
19		9336023	9			2012.04.28-2022.04.27
20		9335971	9			2014.06.14-2024.06.13

--	--	--	--	--	--	--

21



13894102

9

2015.2.21-2025.2.20

2		6350900	7 37			2020.08.31-20 30.08.31	

4

1		ZL201910 174089.6			2019.03.08	2021.06.18	
2		ZL201811 530898.8			2018.12.14	2021.05.18	
3		ZL201510 367887.2			2015.06.29	2020.10.30	
4		ZL201510 566078.4			2015.09.08	2020.08.28	
5		ZL201710 862974.4			2017.09.22	2020.08.28	
6		ZL201810 071252.1			2018.01.25	2020.08.28	
7		ZL201510 694985.7			2015.10.22	2020.07.31	
8		ZL201810 678394.4			2018.06.27	2020.07.03	
9		ZL201610 153803.X			2016.03.16	2020.04.24	
10		ZL201711 121821.0			2017.11.14	2020.04.24	
11		ZL201711 363054.4			2017.12.18	2020.04.24	
12		ZL201510 717077.5			2015.10.29	2020.01.10	
13		ZL201710 705141.7	RF		2017.08.17	2019.12.13	
14		ZL201510 676243.1			2015.10.13	2019.12.06	
15		ZL201711 225305.2			2017.11.29	2019.09.06	
16		ZL201410 449129.0			2014.09.04	2019.07.19	

17	ZL201610 695640.8								
----	----------------------	--	--	--	--	--	--	--	--

41		ZL201510 492800.4			2015.08.12	2018.01.12	
42		ZL201510 516352.7			2015.08.21	2018.01.12	
43		ZL201510 178153.X			2015.04.15	2017.11.21	
44		ZL201510 582457.2			2015.09.14	2017.11.21	
45		ZL201510 152481.2			2015.04.01	2017.10.03	
46		ZL201510 541793.2			2015.08.28	2017.09.05	
47		ZL201510 359908.6			2015.06.25	2017.08.11	
48		ZL201510 179038.4			2015.04.15	2017.03.22	
49		ZL201410 240588.8			2014.05.30	2016.09.28	
50		ZL201410 370562.5			2014.07.30	2016.09.28	
51		ZL201510 315852.4			2015.06.10	2016.09.28	
52		ZL201410 406792.2			2014.08.15	2016.08.24	
53		ZL201410 440010.7			2014.09.01	2016.08.24	
54		ZL201410 508728.5			2014.09.28	2016.08.24	
55		ZL201310 602849.1			2013.11.22	2016.05.04	
56		ZL201310 195971.1			2013.05.23	2016.04.20	
57		ZL201310 199669.3			2013.05.24	2016.04.20	
58		ZL201410 140942.X			2014.04.10	2016.04.20	
59		ZL201310 398225.2			2013.09.04	2016.03.09	
60		ZL201310 117784.1			2013.04.07	2015.11.04	
61		ZL201310 211397.4			2013.05.30	2015.11.04	
62		ZL201210 514325.2			2012.12.05	2015.09.09	
63		ZL201210 288972.6			2012.08.14	2015.04.22	
64		ZL201110 424784.7			2011.12.16	2015.02.04	

65		ZL201210 321976.X			2012.09.03	2014.10.22	
66		ZL201210 375767.3			2012.09.29	2014.02.05	
67		ZL201210 271694.3			2012.08.01	2013.09.18	
68		ZL201010 005335.4			2010.01.15	2012.05.02	
69		ZL200610 046308.5			2006.04.14	2009.05.20	
70		ZL201820 036849.8			2018.01.10	2018.09.11	
71		ZL201620 685450.3	OLED		2016.07.01	2017.04.12	
72		ZL201620 396190.8			2016.05.05	2016.09.28	
73		ZL201620 114034.8			2016.02.04	2016.08.17	
74		ZL201520 317354.9			2015.05.18	2016.08.03	
75		ZL201520 646553.4			2015.08.25	2016.07.20	
76		ZL201520 805012.1			2015.10.16	2016.04.20	

88		ZL201520 821306.3			2015.10.22	2016.03.09	
89		ZL201520 821972.7			2015.10.21	2016.03.09	
90		ZL201520 829090.5			2015.10.23	2016.03.09	
91		ZL201520 347037.1			2015.05.27	2016.01.20	
92		ZL201520 455971.5			2015.06.29	2016.01.20	
93		ZL201520 317367.6			2015.05.18	2015.12.30	
94		ZL201520 327981.0			2015.05.20	2015.12.30	
95		ZL201520 455915.1			2015.06.29	2015.12.30	
96		ZL201520 502627.7			2015.07.13	2015.12.30	
97		ZL201520 527443.6			2015.07.20	2015.12.30	
98		ZL201520 527507.2			2015.07.20	2015.12.30	
99		ZL201520 546543.3			2015.07.23	2015.12.30	
100		ZL201520 549366.4			2015.07.27	2015.12.30	
101		ZL201520 555722.3			2015.07.29	2015.12.30	
102		ZL201520 575581.1			2015.08.03	2015.12.30	
103		ZL201520 646244.7			2015.08.25	2015.12.30	
104		ZL201520 646274.8			2015.08.25	2015.12.30	
105		ZL201520 646968.1			2015.08.25	2015.12.30	
106		ZL201520 328483.8			2015.05.20	2015.11.11	
107		ZL201520 420234.1			2015.06.17	2015.11.11	
108		ZL201520 455222.2			2015.06.29	2015.11.11	
109		ZL201520 328874.X			2015.05.21	2015.11.04	
110		ZL201520 329524.5			2015.05.19	2015.11.04	

111		ZL201520 346370.0			2015.05.26	2015.11.04	
112		ZL201520 348267.X			2015.05.26	2015.11.04	
113		ZL201520 362576.2			2015.05.29	2015.11.04	
114		ZL201520 364144.5			2015.05.29	2015.11.04	
115		ZL201520 217190.2			2015.04.13	2015.09.09	
116		ZL201520 217252.X			2015.04.13	2015.09.09	
117		ZL201520 336879.7			2015.05.21	2015.09.09	
118		ZL201420 426472.9			2014.07.30	2015.02.04	
119		ZL201420 426501.1			2014.07.30	2015.02.04	
120		ZL201420 482962.0			2014.08.25	2015.02.04	
121		ZL201420 508941.1			2014.09.04	2015.01.07	
122		ZL201420 509410.4			2014.09.04	2015.01.07	
123		ZL201420 513408.4			2014.09.05	2015.01.07	
124		ZL201420 357522.2			2014.06.30	2014.12.03	
125		ZL201420 378899.6			2014.07.10	2014.12.03	
126		ZL201420 379260.X			2014.07.10	2014.12.03	
127		ZL201420 198568.4			2014.04.22	2014.10.22	
128		ZL201420 244421.4			2014.05.13	2014.10.22	
129		ZL201320 682537.1			2013.10.31	2014.04.23	
130		ZL201320 682574.2			2013.10.31	2014.04.23	
131		ZL201320 683055.8			2013.10.31	2014.04.23	
132		ZL201320 684941.2			2013.10.31	2014.04.23	
133		ZL201320 685738.7			2013.10.31	2014.04.23	
134		ZL201320 686908.3			2013.10.31	2014.04.23	

135		ZL201320 687868.4			2013.11.01	2014.04.23	
136		ZL201320 304672.2			2013.05.29	2013.12.18	
137		ZL201320 414050.5			2013.07.12	2013.12.18	
138		ZL201320 272540.6			2013.05.17	2013.11.13	
139		ZL201320 126868.7			2013.03.19	2013.09.18	
140		ZL201220 509946.7			2012.09.29	2013.04.24	
141		ZL201220 435143.1			2012.08.29	2013.03.27	
142		ZL201220 435287.7			2012.08.29	2013.03.13	
143		ZL201220 445614.7			2012.09.03	2013.03.13	
144		ZL201220 445914.5			2012.09.03	2013.03.13	
145		ZL201930 676610.7			2019.12.05	2020.07.03	
146		ZL201910 467555.X			2019-05-31	2021-09-03	
147		ZL201910 077771.3			2019-01-28	2021-09-03	
148		ZL201910 663986.3			2019-07-23	2021-08-10	
149		ZL201810 413913.4			2018-05-03	2021-08-06	
150		ZL201911 226243.6			2019-12-04	2021-07-09	
151		ZL201910 205635.8			2019-03-19	2021-07-06	
152		ZL201810 400714.X			2018-04-28	2021-11-12	
153		ZL201910 401332.3			2019-05-15	2022-1-14	

1		TW108125859			2019.07.22	2020.11.01	
2		TW108125855			2019.07.22	2020.09.11	

3		TW108125375				2019.07.18	2020.09.11	
4		TW106136726	RF			2017.10.25	2020.08.21	
5		TW108119619				2019.06.06	2020.08.21	
6		US 10,643,882 B2	A CERAMIC RING WITH LADDER STRUCTURE			2017.08.18	2020.05.05	
7		TW108106531				2019.02.26	2020.04.01	
8		TW108110364				2019.03.26	2020.02.11	
9		US 10,410,909 B2	WAFFER PEDESTAL AND SUPPORT STRUCTURE THEREOF			2018.09.17	2019.09.10	
10		TW107113431				2018.04.20	2019.06.01	
11		TW107113432				2018.04.20	2019.04.11	
12		TW107113433				2018.04.20	2019.02.11	
13		TWI634612				2016.04.21	2018.09.01	
14		TWI605149				2016.06.22	2017.11.11	
15		TWI604558				2016.11.14	2017.11.01	
16		TWI547976				2014.01.17	2016.09.01	
17		US 10,497,591 B2	LOAD LOCK CHAMBER AND THE CLUSTER			2016.09.16	2019.12.03	

			TOOL SYSTEM USING THE SAME					
18		TWI735914				2019.07.18	2021.08.11	
19		TWI734285				2019.12.05	2021.07.21	
20		TWI741306B				2019.06.06	2021.10.01	
21		US11088012B2	Wafer susceptor apparatus with thermal insulation and method for manufacturing the same			2019.04.05	2021.08.10	

5

1								
"	1	36		/				
/								
2	/						"	/
2								
"	1	36		"		"		
2				3		3		
3	36	6		20				
			"		"			
			6					

4									
5								25%	
6			4						
7			25%						
	"			"					"
3									
"	1					36			
2									
						"			
4		11							
"	1					36			
2									
			"		"				
	"								
5									
"	1				12		/		
/									
2	/							/	/
			"		"				/
							/		
			"						
1									
"	1								
2									
3									

4
5%
3
6
5
6
"

2
" 1
/
/
2
/
/
3
/
4
/
5% /
3 /
6
5 / / /
6
/
"

3
5%
" 1
/

2	/	/		
3	/			
4	/			/
			5%	/
		6	3	/
5	/	/	/	
6	/			
		"		

--	--	--	--	--

1				"
"	2021			
1			20	20
	"	"	20	
				20
			/	
2				
3				

a				10
b				
	30			
				10%
				20%
				50%
4				
		5		
<hr/>				
2				
1				
"		"	"	
				"
2				
"		"	"	

	<p data-bbox="268 409 288 439">3</p> <p data-bbox="236 533 252 555">"</p> <p data-bbox="603 577 619 600">"</p> <p data-bbox="738 577 754 600">"</p> <p data-bbox="1310 371 1326 394">"</p> <p data-bbox="268 864 288 893">4</p> <p data-bbox="236 987 252 1010">"</p> <p data-bbox="632 1032 647 1055">"</p> <p data-bbox="767 1032 783 1055">"</p> <p data-bbox="1031 824 1046 846">"</p> <p data-bbox="1310 1323 1326 1346">"</p>
<p data-bbox="236 1429 256 1458">1</p> <p data-bbox="236 1592 252 1615">"</p> <p data-bbox="296 1592 317 1621">1</p> <p data-bbox="268 1677 288 1706">2</p> <p data-bbox="268 1964 288 1993">3</p>	

"
2
" 1
2
3
"
1
" 1
2
3
4

<p>5</p> <p style="text-align: center;">3</p> <p style="text-align: right;">"</p>
<p>2</p> <p>" 1</p> <p>2</p> <p style="text-align: center;">"</p>
<p>1</p> <p>2021</p> <p style="text-align: center;">" "</p> <p>1</p>

<p>2</p> <p>3</p> <p>4</p> <p>5</p> <p>10%</p> <p>20%</p>
<p>2</p> <p>" 1</p> <p>2 "</p>
<p>1</p> <p>" " " "</p>

"	
2	
"	1
2	
"	
3	
"	1
2	
3	
"	

4
" 1

	/								
		/							"
"	1								
2									
3									"
	5%								
1		/	/	/	/				
2		/	/	/	/				
	1								
	"	"	"	2					
3	"	"						1	/ /
	5%							2	
1									
"	1								
2									
3									

4	"
2	
"	<p>1 / / / / / / /</p>
2	<p>2 / / / / / / / "</p>
3	<p>3 / / / / / / / / / /</p>
4	<p>4 / / / / / / / / / / / /</p>
5	<p>5 / / / / / / / / / / / /</p>
	"
1	"
	"
2	

"	3 " "	4 "	5 " " 2021 0620 2021 0621 "
---	-------------	--------	--